

Supplemental Design, Installation, And Acceptance Guide for Fire and Life Safety Systems

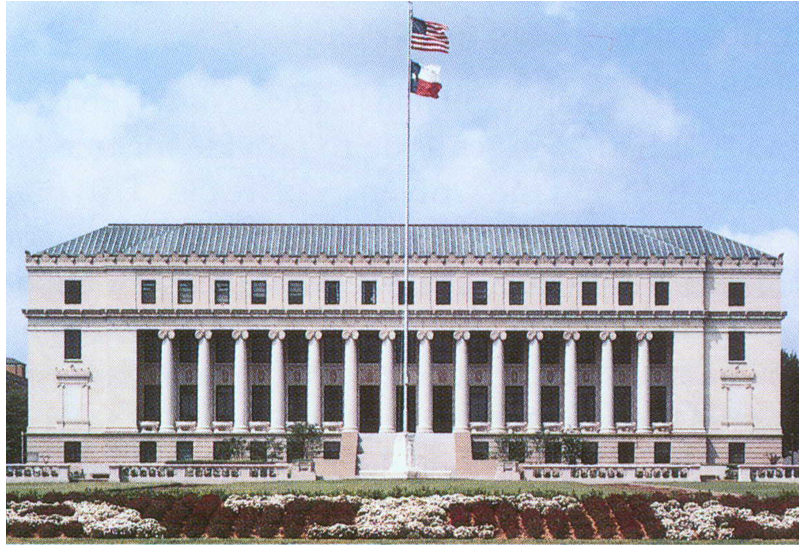

**ENVIRONMENTAL
HEALTH & SAFETY**
TEXAS A&M UNIVERSITY



Drafted
April 2, 2018

Last Revision
April 2, 2018

**Texas A&M University
Supplemental Design, Installation, and Acceptance
Guide for Fire and Life Safety Systems**

Submitted by: James Rainer
Assistant Director, EHS
Local AHJ

Original Signed By

Christina Robertson
Director, EHS

Date

Original Signed By

Christopher M. Meyer
Associate Vice President for Safety and Security

Date

Original Signed By

Dr. Jerry R. Strawser
Executive Vice President and Chief Financial Officer

Date

Table of Contents

Purpose Statement.....	5
Fire and Life Safety Commitment.....	5
Fire and Life Safety Program.....	5
Program Requirements.....	5
Fire Protection Engineering Services.....	5
Licensed, Registered, and Certified Personnel.....	6
Applicable Codes and Standards.....	6
Fire Safety During Construction, Alteration, and Demolition Operations.....	6
Facility Remodels.....	6
Construction Related Texas A&M University Rules/Standard Administrative Procedures/Programs.....	6
Acronyms.....	9
Fire and Life Safety Systems Summary Table.....	10
EHS Permitting Process (Reserved).....	12

Design and Installation Guidelines and Specifications

Backflow Preventers.....	13
Clean Agent Fire Extinguishing Systems.....	13
Elevators.....	13
Emergency Lights/Exit Signage.....	13
Emergency and Standby Power Systems.....	14
Fire Alarm Systems.....	14
Fire Alarm Reporting System Interface.....	15
Fire Department Connections.....	16
Fire Door Assemblies.....	16
Fire/Smoke Dampers.....	16
Fire Extinguishers (Portable).....	16
Fire Extinguisher Cabinets.....	18
Fire Hydrants.....	18
Fire Lanes(Aerial Fire Apparatus Access Roads).....	19
Fire Lane Marking.....	19
Fire Pumps.....	19
Fire Rated Walls/Partitions.....	19
Fire Sprinkler Systems.....	20
Fixed Extinguishing Systems.....	21
Fuel Gas (Liquefied Natural Gas LNG/Liquefied Petroleum Gas LPG).....	21
Gas/Environmental Monitors.....	22
Key Boxes.....	22
Kitchen Hood and Duct Suppression Systems.....	22
Post Indicating Valves.....	23
Room Identification/Numbering.....	23
Smoke Management Systems.....	23
Standpipe and Hose Valve Systems.....	23

Inspection and Acceptance

Backflow Preventer.....	24
Clean Agent Fire Extinguishing Systems.....	24
Elevators.....	24
Emergency Lights/Exit Signage.....	24
Emergency and Standby Power Systems.....	24
Fire Alarm Systems.....	25
Fire Dampers/Smoke Dampers.....	26
Fire Door Assemblies.....	26
Fire Extinguishers.....	26
Fire Extinguisher Cabinets.....	26
Fire Hydrants.....	26

Fire Lanes/Aerial Fire Apparatus Access Roads	27
Fire Pumps.....	27
Fire Rated Walls/Partitions	27
Fire Sprinkler Systems	27
Fixed Extinguishing Systems	28
Fuel Gas (Liquefied Natural Gas LNG/Liquefied Petroleum Gas LPG).....	28
Gas/Environmental Monitors	28
Kitchen Hood and Duct Suppression Systems	28
Key Boxes	29
Post Indicator Valves.....	29
Smoke Management/Control Systems	29
Standpipe and Hose Valve Systems	29

Annexes

Annex A – TAMU Fire Alarm System Design and Installation Standard	30
Annex B – Texas State Fire Marshal Gas Directive.....	37
Annex C – Example Photographs	40
Annex D – College Station Fire Department Construction and Development Guide	43

Attachments

Attachment I – Clean Agent Fire Extinguishing System Acceptance Checklist	72
Attachment II – Elevator Acceptance Checklist.....	75
Attachment III – Emergency Power Supply Systems Acceptance Checklist	77
Attachment IV – Emergency Lighting Acceptance Checklist	83
Attachment V – Fire Alarm Certificate of Installation (TDI-SFM)	86
Attachment VI – Fire Alarm System Acceptance Checklist.....	88
Attachment VII – Fire Pump Acceptance Checklist.....	91
Attachment VIII – Contractor’s Material and Test Certificate for Aboveground Piping (TDI-SFM).....	93
Attachment IX – Contractor’s Material and Test Certificate for Underground Piping (TDI-SFM)	96
Attachment X – Dry Pipe Sprinkler Acceptance Checklist	99
Attachment XI – Automatic Sprinkler System Acceptance Checklist	102
Attachment XII – Hydrostatic Acceptance Checklist	105
Attachment XIII – Pre-Action Fire Sprinkler System Acceptance Checklist.....	107
Attachment XIV – Deluge Fire Sprinkler System Acceptance Checklist	110
Attachment XV – Fuel Gas Test Form.....	113
Attachment XVI – Kitchen Hood and Duct Extinguisher System Acceptance Checklist.....	115
Attachment XVII – Fixed Extinguishing System Installation Certificate (TDI-SFM).....	117
Attachment XVIII – Smoke Management Systems Acceptance Checklist.....	119
Attachment XIX – Smoke Management Systems – Stairwell Pressurization System Acceptance Checklist.....	122
Attachment XX – Standpipe and Hose Valve System Acceptance Checklist.....	124
Attachment XXI – EHS Project Final Completion Checklist	127
Revision Log.....	129

Construction Fire and Life Safety

Purpose Statement

The purpose of this document is to provide architects, engineers, contractors, and others a guideline as to the fire and life safety requirements for any new construction or renovations on the Texas A&M University (TAMU) campuses (TAMU McAllen, Law School in Ft. Worth, etc.), the TAMUS RELLIS Campus, and Texas A&M University Health Science Center Facilities located throughout the state of Texas. This document is not intended to take the place of any required code, standard, or project specification, but rather to supplement such. Nor is this document intended to supersede any code or project specification, and is not intended to serve as an all-inclusive document, but rather as a guide for what systems are required, specific equipment models, an outline as to the acceptance procedure that will be followed by TAMU Environmental Health and Safety (EHS), forms that EHS will use, and what documentation/certification will need to be submitted to EHS by the Architect, Engineer, Contractor, etc. If a conflict arises between a code, standard, or the project specifications and this document, the TAMU Authority Having Jurisdiction (AHJ) and other appropriate project team members will review the information and come to a mutual agreement prior to the affected project phase.

Fire and Life Safety Commitment Statement

TAMU is committed to providing a safe environment for all faculty, staff, students, visitors and emergency response personnel. Fire and life safety at Texas A&M University is governed by federal, state and local standards including System Regulations, University Rules, and University Standard Administrative Procedures. Ultimate jurisdiction for fire safety lies with the Texas State Fire Marshal and with the local Authority Having Jurisdiction (AHJ) as designated by the President of Texas A&M University. By presidential designation, the Assistant Director for Fire and Life Safety Program in Environmental Health and Safety is designated to be the local AHJ and to be responsible for the day to day fire prevention, inspections, and program oversight. However, each and every individual, whether faculty, staff, student, or visitor on our campus shares a role in fire safety.

Fire and Life Safety Program

The fire and life safety program at TAMU involves numerous activities, programs, and procedures to help ensure that our campus is a safe place to work, live, and play. These program areas include fire prevention, fire suppression, emergency preparedness, preplanning, education, construction review and inspection, and response. The following information is provided as a general guideline for activities associated with fire and life safety. Additional information may be obtained by contacting Environmental Health and Safety or by going to our website for the latest information. Links are provided throughout this document.

Program Requirements

The basis for the fire and life safety program at TAMU is provided for by TAMU System regulation:

24.01.01 Supplemental Risk Management Standards

<http://www.tamus.edu/offices/policy/policies/pdf/24-01-01.pdf>

24.01.01.M4 – Environmental Health and Safety Programs

<http://rules-saps.tamu.edu/PDFs/24.01.01.M4.pdf>

24.01.04.M7 - Fire and Life Safety Compliance

<http://rules-saps.tamu.edu/PDFs/24.01.04.M7.pdf>

Fire Protection Engineering Services

Any project involving a new facility or renovation greater than 20,000 gross square foot, any facility incorporating/requiring special hazards/special hazard protection, or any project where an alternate means of compliance to code is proposed, shall incorporate the services of a registered fire protection engineer who has relevant experience in the area(s) that requires these services. The AHJ may request these services if in any situation where in their opinion, code compliance is not being met or may upon special circumstances omit this requirement.

Licensed, Registered, and Certified Personnel

Any design, installation, testing, certification, or similar activity where licensed, registered, or certified personnel are required by an applicable code, standard, standard practice, etc. shall be conducted by such personnel with the applicable and current license, registration, certification etc. Copies of such license(s) shall be provide to the AHJ upon request.

Any requirements that are identified by a code or standard but without specific value or test method shall be determined by the design professional and included in the design documents.

Applicable Codes and Standards

The Texas State Fire Marshal's Office has adopted the National Fire Protection Association 101, *Life Safety Code*® (NFPA 101) and NFPA 1, *Fire Code*® (NFPA 1) as the primary guide for fire and life safety. Texas A&M University is currently utilizing the 2018 edition of each of these codes. Additionally, all applicable referenced codes and standards within these documents are included and shall be incorporated as appropriate. Where items are not addressed by these codes, the following documents shall serve as guidance documents for any design and construction issues.

- International Building Code – 2018 edition (Including Appendix B, C, D, E, F, G, H, and I)
- International Fire Code – 2018 edition
- International Mechanical Code – 2018 edition
- International Plumbing Code – 2018 edition
- Texas Accessibility Standards Act
- Americans with Disabilities Act

Fire Safety During Construction, Alteration, and Demolition Operations

Any contractor conducting any construction, alteration, or demolition operations shall incorporate applicable requirements of NFPA 241, *Standard for Safeguarding Construction, Alteration, and Demolition Operations*, as a condition of the construction process (incorporated by reference from NFPA 1).

Facility Remodels

Any project involving a remodel of a facility with an existing fire alarm, fire sprinkler, standpipe, or any other type of life safety system shall include within the scope of the design, provisions to connect to, expand, or modify any of the existing systems. This scope shall include at a minimum:

- Updating system design calculations (sprinkler flow, battery capacity, etc.)
- Updating as-built drawings and related documents
- Updating any graphics packages associated with these systems (i.e. – addressable fire alarm systems with integrated graphics packages)
- Updating any associated programming with such systems (ex: software updates for addressable fire alarm systems).

Construction Related TAMU Rules/Standard Administrative Procedures/Programs

University Utility Locate Procedures – To increase the level of safety, TAMU has a policy that is more strict than State law and requires an advance locate be performed for: 1) any ground penetration on campus, to any depth, when mechanized equipment such as augers, trenchers, excavators, etc. will be used, and 2) for all other ground penetrations to a depth greater than 12 inches. Hand-digging or soft excavation is required whenever any excavation is performed to a depth less than 12 inches without a utility locate. An advance utility locate is always required if the excavation will be deeper than 12 inches.

24.99.99.M0.01 – *University Utility Locate Procedures*

<http://rules.tamu.edu/PDFs/24.99.99.M0.01.pdf>

Stormwater Management and Protection – Texas A&M University is committed to conducting its activities as a responsible steward of the environment. In accordance with the University’s environmental commitment and the Texas Pollutant Discharge Elimination System (TPDES) General Permit TXR040000 for Small Municipal Separate Storm Sewer Systems (MS4), Texas A&M has established a Stormwater Management Plan and this procedure to provide methods for controlling the introduction of pollutants in the stormwater drainage system.

24.99.99.M0.03 – *Stormwater Management and Protection*

<http://rules.tamu.edu/PDFs/24.99.99.M0.03.pdf>

Slow Moving Vehicles – This procedure and regulations have been created to establish proper safety procedures; identification and registration; parking; routes; and access for Slow Moving Vehicles operated on university property and to provide a safe environment for students, faculty, staff, and university visitors.

34.99.99.G0.01 – *Slow Moving Vehicles*

[http://rules-saps.tamu.edu/\(X\(1\)S\(2ljj4z450xtqn1nscpubntek\)\)/PDFs/34.99.99.G0.01.pdf](http://rules-saps.tamu.edu/(X(1)S(2ljj4z450xtqn1nscpubntek))/PDFs/34.99.99.G0.01.pdf)

Asbestos Free Certification – It is the intent that any new construction be designated as “asbestos-free”. To establish a facility “asbestos-free” the following is required from a Texas-registered architect or Texas-licensed professional engineer:

During the construction of or renovation in a public building, a person appropriately licensed in accordance with these rules, Texas registered architect or Texas-licensed professional engineer may compile the information from safety data sheets (SDS) of all products used in the construction of the building and, finding no asbestos in any of those products, prepare a signed written certification that he has reviewed the SDSs for all products used in the construction and that none of those products contain ACBM and; therefore, the building materials do not contain asbestos.

More requirements from the Texas Asbestos Health Protection Rules:

(i) A person may not install building materials or replacement parts as stated in subsection (j) of this section, in a public building unless:

- (1) the person obtains a required SDS showing that the materials or replacement parts contain 1.0% or less of asbestos; or
- (2) the materials or replacement parts, according to the SDS, contain more than 1.0% asbestos but there is no alternative material or part as demonstrated by the building owner or contractor.

(j) A SDS shall be obtained for the following building materials or replacement parts including but not limited to:

- (1) surfacing materials:
 - (A) acoustical plaster;
 - (B) decorative plaster/stucco;
 - (C) textured paint/coating;
 - (D) spray applied insulation;
 - (E) blown-in insulation;
 - (F) fireproofing insulation;
 - (G) joint compound; and
 - (H) spackling compounds.
- (2) thermal system insulation:
 - (A) taping compounds (thermal);
 - (B) HVAC duct insulation;
 - (C) boiler insulation;
 - (D) breaching insulation;
 - (E) pipe insulation; and
 - (F) thermal paper products.
- (3) miscellaneous material:
 - (A) cement pipes;
 - (B) cement wallboard/siding;
 - (C) asphalt/vinyl floor tile;
 - (D) vinyl sheet flooring/vinyl wall coverings;
 - (E) floor backing;
 - (F) construction mastic;
 - (G) ceiling tiles/lay-in ceiling panels;
 - (H) packing materials;
 - (I) high temperature gaskets;

- (J) laboratory hoods/table tops;
- (K) fire blankets/curtains;
- (L) elevator equipment panels;
- (M) elevator brake shoes;
- (N) ductwork flexible fabric connections;
- (O) cooling towers;
- (P) heating and electrical ducts;
- (Q) electrical panel partitions;
- (R) electrical cloth/electrical wiring insulation;
- (S) chalkboards;
- (T) roofing shingles/tiles;
- (U) roofing felt;
- (V) base flashing;
- (W) fire doors;
- (X) caulking/putties;
- (Y) adhesives/mastics; and
- (Z) wallboard.

Duress Alarms – This procedure and regulations have been created to notify and receive approval for any intrusion/duress alarms that will result in an anticipated response by the University Police Department.

25.99.99.M0.04 – *Pre-approval Requirements for Specified Equipment, Supplies, Vehicles, and Services* (04-18-2016)

<http://rules-saps.tamu.edu/PDFs/25.99.99.M0.04.pdf>

Acronyms

AHJ – Authority Having Jurisdiction
ASME – American Society of Mechanical Engineers
BFD – Bryan Fire Department
CSFD – College Station Fire Department
EDCS – SSC Engineering and Design Services
EHS – Texas A&M University Environmental Health & Safety
ETJ – Extra Territorial Jurisdiction
FACP – Fire Alarm Control Panel
FAS – Fire Alarm System
FM – Factory Mutual
FP&C – Texas A&M University System Office of Planning and Construction
ICC – International Code Council
IBC – International Building Code
IFC – International Fire Code
LSC – National Fire Protection Association 101, *Life Safety Code*®
RELLIS – Texas A&M University System Campus (Formally Riverside Campus)
SSC – SSC Service Solutions
NICET – National Institute for Certification in Engineering Technologies
NFPA – National Fire Protection Association
O&M – Operations and Maintenance
SFM – State Fire Marshal, specifically the Texas State Fire Marshal
TAMU – Texas A&M University
TAMUS – Texas A&M University System
UL – Underwriters Laboratories
UPD – Texas A&M University Police Department

Fire Safety Systems Summary Table*

Fire Safety System	Guidelines	Code/Standard/Guidance References	Acceptance Form(s)	Required Documentation**	Comments
Backflow Preventers	Yes	NFPA 13; NFPA 14	State	Backflow Certification	Preferred manufacturer Watts; Model varies by application
Card Access/ Controlled Access/ Delayed Egress	No	NFPA 80, NFPA 101			Contact TAMU Building Access for acceptable manufacturers
Clean Agent Suppression Systems	Yes	NFPA 2001	Attachment I	FML-009; O&M Manual; Sensitivity Report	
Elevators		ASME A17.1, NFPA 13, NFPA 72, NFPA 101	Attachment II	State Elevator Certification (Temporary)	
Emergency Lighting/Exit Signage	Yes	NFPA 101, NFPA 110	Attachment III		
Emergency Power Supply Systems	Yes	NFPA 110, NFPA 101	Attachment IV	Evidence of the prototype test (for Level 1 Systems); Certified analysis; Letter of Compliance; Manufacture's certification of a rated load test at rated power factor with ambient temperature, altitude and fuel grade; Schematic wiring and interconnection diagrams; O&M Manuals	
Fire Alarm Systems	Yes	NFPA 72, NFPA 101	Attachment V, VI	FML-009 Form; Record of Completion; As Built Drawings; Sensitivity Test Report	
Fire Dampers/Smoke Dampers	Yes	NFPA 1, NFPA 72, NFPA 80, NFPA 101, NFPA 105		As-built drawing indicating locations	
Fire Department Connections	Yes	NFPA 13, NFPA 13R, NFPA 14; Annex D,			www.knoxbox.com
Fire Doors/Motorized Fire Doors	Yes	NFPA 80		O&M Manuals	
Fire Extinguishers/ Fire Extinguisher Cabinets	Yes	NFPA 1, NFPA 10, NFPA 101			
Fire Hydrants	Yes	NFPA 291; IFC; Annex D			
Fire Lanes/ Aerial Access Ways/Fire Lane Marking	Yes	Annex D; IFC		Engineering documents for "soft" surfaces	

Fire Safety System	Guidelines	Code/Standard/Guidance References	Acceptance Form(s)	Required Documentation**	Comments
Fire Pumps	Yes	NFPA 20, NFPA 72	Attachment VII	Manufactures Initial Flow and Voltage Test; Installers Fire Pump Flow Test; O&M manual; As-Built drawings	
Fire Rated Walls/Partitions	Yes	NFPA 101			
Fixed Extinguishing Systems	Yes	NFPA 17, NFPA 17A	Attachment XIII	FML-010; O&M manual; As-Built drawings	
Fuel Gas - Natural Gas & Liquefied Petroleum Gas	Yes	NFPA 54, NFPA 58; TAMU Fuel Gas Management Plan; IFGC	Attachment XI	Pressure Test Form(s)	
Key Boxes/Key System	Yes	Annex D; IFC			Complete on-line for BFD, CSFD, UPD. EHS reserves the option to require locks be dual keyed to both BFD/CSFD. www.knoxbox.com
Kitchen Hood & Duct Suppression Systems	Yes	NFPA 1, NFPA 17, NFPA 17A, NFPA 72, NFPA 96, NFPA 101	Attachment XII, XIII	FML-010; O&M manual; As-Built drawings	
Room Numbering	Yes	http://rules-saps.tamu.edu/PDFs/51.99.99.M0.02.pdf ;			
Signage	No	NFPA 1, NFPA 13, NFPA 4, NFPA 101; TAMU SAP http://rules-saps.tamu.edu/PDFs/51.99.99.M0.02.pdf ; Annex D			
Smoke Management Systems	Yes	NFPA 1, NFPA 92, NFPA 92A, NFPA 92B, NFPA 101	Attachment XIV	O&M manual; As-Built drawings	
Sprinkler Systems	Yes	NFPA 1, NFPA 13, NFPA 13D, NFPA 13R, NFPA 14, NFPA 72, NFPA 101		As-built drawings with riser diagram, Backflow Valve Certification, O&M Manual(s); Contractor's Material and Test Certificate for Underground Piping; Contractor's Material and Test Certificate for Aboveground Piping;	
Stairwell Pressurization Systems	No	NFPA 1, NFPA 101	Attachment XV	O&M manual; As-Built drawings; Engineering design documentation	
Standpipe Systems	Yes	NFPA 14	Attachments VI, VII, XVI	As-built drawings with riser diagram, Underground Certification, Above Ground Certification, Backflow Valve Certification, O&M Manual(s)	

* This table is designed to provide a general list of codes, standards, forms, and documentation required for each component. It is not an all-inclusive list.

** Required documentation may be submitted electronically.

EHS Permitting Process

(Reserved)

Design and Installation Guidelines and Specifications

Backflow Preventers

All fire suppression systems shall incorporate a backflow preventer in accordance with the applicable codes and standards.

Preferred manufacturer: Watts

Clean Agent Fire Extinguishing Systems

If approved by the AHJ, clean agent fire extinguishing systems may be installed. All clean agent system installations on Texas A&M Campuses shall conform to the requirements of the most recent edition of the applicable sections of NFPA 2001, *Clean Agent Fire Extinguishing Systems*, and the following requirements.

All clean agent systems shall be provided with a reserve agent supply and connected to the distribution piping to allow for uninterrupted protection and easy changeover from the primary agent supply.

Design and Installation:

All shop drawings, specifications, and submittals shall be submitted to the AHJ for approval prior to installation.

- Shop Drawings shall have a uniform scale and include at a minimum the following:
 - Device legend.
 - Enclosure cross section, full height or schematic diagram, including location and construction of building floor/ceiling assemblies above and below, raised access floor and suspended ceiling.
 - Agent being used.
 - Design concentration of agent.
 - Description of occupancies and hazards being protected, designating whether or not the enclosure is normally occupied.
 - Description of the agent storage containers used including internal volume, storage pressure, and nominal capacity expressed in units of agent mass or volume at standard conditions of temperature and pressure.
 - Plan view of protected area showing enclosure partitions (full and partial height); agent distribution system including agent storage containers, piping, and nozzles; detection, alarm, and control system including all devices; location of controlled devices such as dampers.
 - Complete step-by-step description of the system sequence of operations.

An alarm notification device shall be installed on the exterior of the protected room(s) to indicate that the system has discharged.

An as-built box shall be installed near the main control panel of sufficient size to accommodate any required drawings, etc. This document box shall be a minimum of 16"x16"x6" in size and shall be matching color to the panel, lockable, and require the same key as the main fire alarm panel.

Elevators

Elevators shall be installed in accordance with applicable NFPA, ASME, IBC, IFC and other related codes. Portable fire extinguishers shall be installed inside elevator machine rooms. Machine-room-less elevator control rooms are not required to have an extinguisher installed. Sprinklers shall not be installed in elevator shafts unless specifically required based on materials requiring such suppression.

Emergency Lights/Exit Signs

All emergency lights and exit signage shall be designed in accordance with the requirements of the applicable NFPA codes and standards. It is preferred that any such lighting be powered by an emergency generator in lieu of battery operated devices. Exceptions must be approved prior to construction by the AHJ.

Emergency and Standby Power Systems

All emergency power system installations on Texas A&M Campuses shall conform to the requirements of the most recent edition of NFPA 110 *Standard for Emergency and Standby Power Systems*, NFPA 70 *National Electric Code*, NFPA 101, and any publications referenced therein.

Special consideration should be taken into account during the design phase to differentiate between systems supplying power to emergency or life safety equipment and other equipment not related to life safety but necessary for research, or similar uses. Once installed, all emergency power systems shall be tested, including the operation of associated transfer switches on a monthly basis in accordance with NFPA 110. Therefore it is recommended that a separate generator be used for equipment not related to life safety.

Generators shall be monitored by the fire alarm system for the following conditions:

- Generator run
- Generator fault
- Generator switch in non-automatic condition

For further information, refer to the TAMU Utilities & Energy Services Design Standard for Emergency Generator Systems

<https://utilities.tamu.edu/wp-content/uploads/2015/03/Emergency-Generator-Systems-Automatic-Transfer-Switches-2.2.pdf>

Fire Alarm Systems

Acceptable Manufacturer: Siemens

Acceptable Models: FireFinder XLS and Desigo; others models may be accepted on a case by case basis.

General Requirements:

The complete installation shall conform to the applicable sections of the most current edition of the National Fire Protection Association (NFPA) codes and standards, American with Disabilities Act (ADA), the National Electrical Code, the International Building Code, the Texas Accessibility Standards Act (TAS), and these specifications.

All fire alarm system retrofit projects shall include a field survey of the facility to determine device locations and system layout. The walkthroughs should include a member from the TAMU/TAMUS project management group, fire alarm design team, and EHS.

All new fire alarm systems shall be intelligent, addressable, and equipped with voice notification including public address capability. Exceptions to this shall be on a case by case basis as approved by the AHJ.

All components of the fire alarm system shall be products of an Underwriters Laboratories Inc. listed fire alarm manufacturer, and shall bear the UL label. Partial listing **shall not** be acceptable.

All components of the fire alarm system shall be able to interface completely with the fiber network reporting system used by Texas A&M University while maintaining a UL listing. In jurisdictions outside of Brazos County, the reporting interface shall be determined by the AHJ in conjunction with the local fire department.

Only new parts, devices, etc. shall be installed at the time of initial installation and to repair a system during a warranty period.

All new fire alarm systems installations at Texas A&M University shall utilize the following general guidelines as a basis for the system layout. These general guidelines are for fully sprinklered buildings. These are general guidelines and may vary as determined by the AHJ during walkthrough and/or plan review sessions.

All components of the fire alarm systems shall use the most current technology available.

Smoke detectors

- Shall be photoelectric unless specified by the AHJ
- Shall be installed in the following locations:

- All corridors and common use spaces such as lobbies, reception areas, etc.
- Intermediate or remote areas where smoke would need to penetrate multiple doors to reach a smoke detector in a corridor or common area
- Conditioned mechanical, electrical, and IT Rooms
- Storage rooms with combustible loads
- At the highest location of smoke collection
- Only where accessible for maintenance
- Smoke detectors shall not be installed in
 - Custodial closets with sinks
 - Non-conditioned pump rooms
- Heat detectors shall not be installed in
 - Break rooms/kitchens
 - Laboratory and other individual rooms protected by and automatic sprinkler system
 - Other areas as determined by the AHJ during design

Manual pull stations shall be installed at the following locations:

- Every level at every enclosed or exterior exit, including exterior mechanical and electrical rooms
- In corridors where travel distance to a pull station exceeds 200 feet
- Every horizontal exit as defined by NFPA 101®

Specific design issues

- High-rise building specifications
 - Provide a fireman's phone system and boxes for phone
 - Provide an unsupervised printer that shall record all system events and time of the event
 - All high-rise buildings shall be programmed for general alarm activation (not high-rise mode)
- Residence Hall specific requirements
 - Smoke detectors shall be installed in all resident hall rooms
 - Activation of any detector shall sound a local and general alarm
 - Activation of a general alarm shall activate sounder bases in all resident hall rooms
- Apartment Buildings
 - Any activation of a smoke alarm within an apartment unit shall activate all detectors within the unit but shall not activate the general alarm
 - Activation of any smoke detector within an ADA unit shall send a supervisory signal to the FACP
 - Activation of general alarm shall activate sounders in all apartment units/bedrooms
- Animal housing areas - Chimes may be installed in animal housing areas (system designer should verify with user to determine if and when this might be necessary)

Fire Alarm Reporting System Interface

All new fire alarm installations on the Texas A&M University campus shall be designed to interface directly with the dedicated fiber optics network. The network utilizes Siemens® technology to link all fire alarm systems on the campus and connect to a central monitoring station. In locations where the fiber network is not available the design shall incorporate an AES-IntelliNet Wireless fire alarm monitor.

General Requirements

Each new FAS installation requires a minimum ¾" conduit to be installed between the FACP and a fiber interface cabinet in the fiber network room.

- Wiring requirements
 - Provide one (1) 18/2 shielded cable between the FACP and the fiber interface cabinet
 - Provide one (1) 14/2 cable between the FACP and the fiber module in the fiber interface cabinet

Panel Specific Requirements

- XLS – The following components are required for interfacing a Siemens XLS FACP to the campus FAS network
 - NIC –C Network Interface Card

- RPM Remote Printer Interface (Provides the 485 Network)
- D2300CP OR D2325CPS (single mode module) Fiber Interface Module
- Desigo – The Siemens Desigo FC 2005 with the Wheelock SP40S Voice Panel and the following components are required for interfacing a Siemens FACP to the campus FAS network via the wireless gateway.
 - AES 7788F-ULP Wireless Interface Module
- Specific components for other panels, if approved, must be verified with Siemens

Code Maroon Interface

Provide AIC module for XLSV FACP for interface to Code Maroon. Provide necessary equipment for standalone voice panel for future interface to Code Maroon.

Fire Department Connections

Fire department connections (FDC) for sprinkler or standpipe systems shall conform to the requirements of the applicable NFPA standards and this document.

Fire department connections shall be within 100 feet of a fire hydrant, or meet the minimum requirement of the local fire department for jurisdictions outside of Brazos County.

All fire department connections with a supply line of four inches or greater shall be provided with a 5” Storz fire department connection with a Knox StorzGuard Cap (Model 5002). The contractor shall purchase and transfer the caps to EHS (thru FP&C or SSC) for inventorying and installation by EHS.

All fire department connections with a supply line of less than four inches shall utilize Knox Caps (Model 3043 unless otherwise specified). The contractor shall purchase and transfer the caps to EHS (thru FP&C or SSC) for inventorying and installation by EHS.

Labeling/signage on sprinkler connections shall be in conformance with NFPA 13 and NFPA 14. If a fire department connection or post indicator valve is not installed on a building and not identifiable as to which building it is related to, signage should be installed to indicate which building/system the FDC or post indicator valve is associated with. The signage shall be of sufficient size and font to be seen by approaching emergency responders (Example: Annex C, Photo #5)

Fire department connection signage shall be installed to ensure that it is readily identifiable. Signage shall be red with white letters “FDC” not less than 6” high and not less than a 1” stroke.

Fire Door Assemblies

All fire doors, frames, hardware, and other portions of the assembly shall be specified in accordance with the applicable building and fire codes and NFPA 80 and shall bare the appropriate labels/ratings as required.

Automatic fire doors/shutters may be permitted by the AHJ with prior approval. The location, type of door, and other specifications shall be required to be submitted for approval during the design process.

Fire/Smoke Dampers

Where required by code all fire and smoke dampers shall be installed. Locations not readily identifiable as such shall be labeled. Access to dampers shall be provided to inspect and test dampers in accordance with applicable codes and standards.

Fire Extinguishers (Portable)

New portable fire extinguishers shall be installed in every new or renovated facility unless approved by the AHJ. Extinguishers shall be clean and free of any dust and construction debris. All extinguishers shall be selected and installed in accordance with

the most recent edition of NFPA 10, *Standard for the Installation of Portable Fire Extinguishers*. If a conflict exists, contact TAMU EHS for clarification or direction.

All fire extinguishers shall bear the current years manufacture date at the time of substantial completion of the facility or renovation if substantial completion falls on or after March 1st of the year. If substantial completion of a project occurs between January 1st and the last day of February, then the previous year’s manufacture date is acceptable. In no case shall an extinguisher be more than one year past its manufacture date.

Extinguishers should be installed in corridors in accessible and conspicuous locations. Wall/ceiling signage shall be installed if the location of extinguishers is not readily visible. Unless travel distance or specific equipment requirements dictate, extinguishers for mechanical, electrical, telecommunication rooms, etc. should be installed in corridors.

Preference should be given to installing extinguishers in corridors and not behind locked doors.

Strap type brackets are not acceptable and shall not be used.

Where type BC fire extinguishers are called for (around electronics, servers, etc.) provide a 5# CO₂ fire extinguisher. In high hazard areas provide a 10#CO₂. Dry powder BC extinguishers shall not be used.

The TAMU standard fire extinguisher is a 10 pound 4A: 80BC rated ABC fire extinguisher with brass valves (acceptable manufacturers and models are provided in Table 1). Where a hazard requires a higher rated classification of extinguisher, the design team shall submit the proposed extinguisher to the AHJ for approval.

The following manufacturers and model numbers are acceptable for the identified extinguisher types. Other models and manufacturers may be accepted. Request to utilize alternate extinguishers shall be submitted and approved prior to purchasing or installation of extinguishers.

10# ABC – Multipurpose Extinguisher	Amerex	B441
	Badger	B10M
	Buckeye	10 HI-SB
20# ABC – Multipurpose Extinguisher	Amerex	A411
	Badger	B20M
	Buckeye	20HI- SB
5# Carbon Dioxide Extinguisher	Amerex	322
	Badger	B5V
	Buckeye	5CD
10# Carbon Dioxide Extinguisher	Amerex	330
	Badger	B10V
	Buckeye	10CD
15# Carbon Dioxide Extinguisher	Amerex	331
	Badger	B15V
	Buckeye	15CD
20# Carbon Dioxide Extinguisher	Amerex	332
	Badger	B20V
	Buckeye	20CD
2.5 Gallon Water (H ₂ O) Extinguisher	Amerex	240
	Badger	WP-61
	Buckeye	500
6L Class K Extinguisher	Amerex	260
	Badger	WC-100
	Buckeye	WC-6
Non Metallic	Badger	B5V-MR

Table 1- Approved Portable Fire Extinguisher Manufacturers and Model Numbers

Extra Extinguishers

Travel distance to extinguishers can be altered by the placement of furniture, equipment, fixtures, cubicles, etc. after construction has been completed. As a result, additional extinguishers are often needed to ensure compliance once occupants have moved into a facility. The project/contractor shall provide additional extinguishers of the types installed in a facility based on the information located in *Table 2*. The number and type of the extra extinguishers shall be representative of the number of extinguishers installed in the facility. This will vary from building to building and may be approximate. Final numbers of the various types of extinguishers should be submitted to the AHJ prior to purchasing extinguishers. Exceptions from this requirement may be granted by the AHJ when the design of the facility limits variations in travel distances.

Number of extinguishers to be installed in building	Extra extinguishers to be transferred to EHS
1-15	1
16-30	2
31-50	3
51-75	4
76-100	5
101-125	6
126-150	7
151-175	8
176-200	9
> 200 & greater	10

Table 2 - Extra Fire Extinguishers

Fire Extinguisher Cabinets

When fire extinguisher cabinets are to be installed the following general guidelines shall be utilized.

Larsen's Cameo series are preferred but other manufacturers and models may be acceptable. Cabinets shall be readily identifiable as a fire extinguisher cabinet or identification must be provided. Wall/ceiling signage shall be installed if the location of extinguishers is not readily visible. Cabinets shall be provided with a pull handle with cam-action latch and non-locking hardware. The hinge and door hardware should be of a type which allows full opening of the door and easy removal of the fire extinguisher.

It is the responsibility of the design firm to ensure that fire extinguisher cabinets that are to be installed will accommodate the selected fire extinguishers.

Mounting brackets inside of fire extinguisher cabinets will not be permitted, except in wet environments to prevent base of extinguisher from rusting.

When installed in a fire rated partition, the cabinet construction rating shall be equivalent to the required partition rating.

Fire Hydrants

Fire hydrants shall be installed in accordance with NFPA 1, NFPA 291, IBC, IFC, the College Station Fire Department Construction and Development Guide (Annex D), and this document. Locations outside of Brazos County will conform to local fire department guidelines.

The preferred hydrant manufacturer for Texas A&M University is American Darling. All new hydrants will be installed with a 5" Storz connection.

Fire hydrants shall be installed so that all portions of all buildings are within 450 feet of a hydrant and not more than 150 feet from a fire lane.

A fire hydrant shall be installed within 100 ft. of any fire department sprinkler or standpipe connection.

In new development areas, hydrants shall be installed a maximum every 1,000 ft. along new roadways.

Fire Lanes (Fire Lanes/Aerial Fire Apparatus Access Roads)

Fire lanes and fire apparatus access roads shall be created for each new facility and shall be designed, installed, and marked in accordance with the International Fire Code, including Appendix D, and the College Station Fire Department Construction and Development Guide (Annex D). Fire lanes shall be a minimum of 20' in width with a vertical clearance of 14'. Locations outside of Brazos County shall conform to local fire department guidelines.

Aerial fire apparatus access roads shall be provided when required by Appendix D of the International Fire Code or as determined by the AHJ during the design phase of the project.

Preliminary site drawings and a project scope shall be submitted to EHS to be reviewed in conjunction with the local municipal fire marshal prior to final design.

The use of drivable "soft" or plantable concrete systems, such as Grasscrete, or similar products may be acceptable. Approval shall be received prior to beginning of construction.

All portions of buildings shall be within 150 ft. of a fire lane. Buildings where this requirement is exceeded shall have a fire lane on more than one side of the building.

Fire Lane Marking

Signage identifying fire lanes or fire apparatus access roads shall be marked in accordance with the requirements of the International Fire Code, including Appendix D, and the College Station Construction and Development Guide (Annex D). Alternate methods shall be submitted to the AHJ for review during the design phase. Locations outside of Brazos County shall conform to local fire department guidelines.

Fire Pumps

All fire pump installations on Texas A&M Campuses shall conform to the requirements of the most recent edition of NFPA 20 *Installation of Stationary Pumps for Fire Protection*, referenced publications therein, and the following requirements.

All fire pump installations shall be provided with emergency power.

All shop drawings, specifications, and submittals shall be submitted to the AHJ for approval prior to installation and may be hard or electronic copy.

Electric driven fire pumps are preferred in lieu of diesel driven pumps.

Drains in pump rooms shall be sufficient to accommodate all inspection and testing at the maximum expected flow.

The location of and access to the fire pump room shall be approved by the AHJ.

Fire pump rooms shall be accessed directly from the exterior of the building.

Fire pump rooms shall be provided with a means of maintaining the temperature above 40°F.

Fire pump rooms shall have emergency lighting installed.

Fire pump test headers shall be installed on the exterior of buildings unless approved by the AHJ prior to installation.

Fire Rated Walls/Partitions

All fire rated walls shall be designed in accordance with the applicable sections of the building and fire codes. Walls located in mechanical rooms, electrical rooms, and other areas shall be stenciled indicating that the wall is rated, specifying the fire resistance rating of the wall (example 2-Hour Rated Wall). The stenciling shall be such that it is easily seen and legible. Finished walls should be indicated above lay-in ceilings when provided. Spacing shall be every 25' on center. See Annex C for example photographs.

Fire Sprinkler Systems

All new construction and major renovation projects shall be provided throughout with an automatic sprinkler system unless approved by the AHJ (major renovation projects include any single renovation affecting more than 50% of the space within a building **or** the cumulative group of projects **or** any change of occupancy). All fire sprinkler installations shall conform to the latest editions of NFPA 13 *Standard for the Installation of Automatic Sprinkler Systems* or NFPA 13R *Standard for the Installation of Automatic Sprinkler Systems*, NFPA 14 *Standard for the Installation of Standpipe and Hose Systems*, NFPA 20 *Standard for the Installation of Fire Pumps*, and NFPA 24 *Standard for the Installation of Private Fire Service Mains*. It is up to the design professional to make the recommendation on the type of system to be installed (wet, dry, pre-action, etc.).

Dedicated main electrical room and emergency power system rooms may be exempted from the requirements for sprinklers with the incorporation of fire resistance rated walls, doors, dampers, etc. as allowed by code.

In buildings where "cloud ceilings" are installed, sprinkler compliance shall conform to the requirements of NFPA 13.

Where shafts are accessible by a door etc., they shall be provided with sprinkler protection at the top and near the bottom of the shaft.

All sprinkler systems with a supply line of four inches or greater shall be provided with a 5" Storz fire department connection. Knox Caps fitting the installed fire department connection shall be provided by the contractor unless approved by the AHJ for local fire departments not utilizing the Knox system. See **Fire Department Connections**

Rooms or areas where it is not desirable to have water filled piping within the room, such as special collections, computer rooms, rooms utilizing water reactive chemicals, etc. may utilize alternative suppression systems with the approval of the AHJ during the design phase of the project.

All sprinkler system equipment shall be new and listed by Underwriters Laboratories (UL) or approved by Factory Mutual (FM). Each major item of equipment shall bear the manufacturer's name or trademark; serial number, and/or UL/FM label.

UL listed flexible drops are permitted where installed in accordance with NFPA 13 and manufacturer's requirements.

A main water flow switch shall be installed at the main riser downstream of the backflow preventer.

All sprinkler systems shall incorporate a water motor gong or electric bell.

Unless otherwise approved by the AHJ, standpipe systems shall be installed in any building 2 or more stories in height.

The design team, in cooperation with the building occupants and sprinkler contractor shall complete an Owner's Information Certificate as outlined in NFPA 13, Chapter 4.

Where open grate flooring is installed (i.e. within a shaft) sprinkler protection shall be installed per NFPA 13 at each floor level under the open grate floor.

Spare heads shall be provided in accordance with the requirements of NFPA 13. The location of the box shall be approved by the AHJ prior to installation. A list of sprinklers installed shall be posted in the spare head box. This list shall include the sprinkler identification number, general description of the head (type, temperature rating), and quantity of each type of head in the box.

Shop Drawings

Shop drawings shall conform to, and include all items as set forth in NFPA 13. Shop drawings, design calculations, cut sheets, and any other submittals shall be submitted to the AHJ for approval prior to installation. Submittals may be in hard copy form or electronic. Partial submittals are not acceptable and will be rejected without review unless prior approval has been obtained from the AHJ.

All material submittals shall include all items listed in the product section and all additional items necessary to provide a complete installation. Where more than one item appears on a manufacturer's catalog sheet, indicate the item or items to be used.

No work shall be performed until the AHJ has approved the shop drawings, calculations, and data sheets. The contractor shall be held liable for any work performed prior to this approval.

Pipe Identification

All sprinkler piping shall be painted red and marked "Fire" or "Fire Protection" unless prior approval is obtained from the AHJ. Pipe markers must be red wrap around type with white letters at a minimum of one (1) inch in height. All pipe markers must be installed so that they are visible from the floor. Spacing and location shall be every 20' for mains and a minimum of one location on each branch line.

Provide all control, drain and test valves with signs identifying the type of valve and the area (floor or portion of the building) affected by the valve. Letters are to be minimum ¼ inch high. Submit the wording for approval (for example, "Control Valve Fourth Floor North"). The signs are to be hung by a chain from the valve. If the system is a hydraulically calculated system, provide a hydraulic information sign in accordance with NFPA 13 (provide scanned/paper copies for the permanent file).

Sprinkler systems consisting of multiple zones and control valves shall have a map displayed within the main riser room identifying each zone by way of color coding. At each floor control valve, in addition to the installed riser tag, an additional map showing zone locations shall be installed.

All valves and drains located above ceiling shall be labeled (and accessible) at the ceiling grid level and be visible from the floor.

Control Valves

A floor control valve assembly and test drain assembly with water flow and tamper devices shall be installed on each floor and/or zone of a building.

Install all control valves, supply valves and test valves in easily accessible locations, with the valve handle or wheel no higher than 7 feet above the finished floor.

Inspector Test and Drain

Main drains shall be sized to accommodate full flow capacity of the sprinkler system main drain. Ensure adequate floor drain capacity exists for operational test of the main drain with a minimum of a ½" gap between the pipe and the funnel/drain.

Fixed Extinguishing Systems

All hood suppression system installations on Texas A&M Campuses shall conform to the requirements of the most recent edition of NFPA 17, *Standard for Dry Chemical Extinguishing Systems*, or NFPA 17A, *Standard for Wet Chemical Extinguishing Systems*, as applicable, and the following requirements.

All suppression systems shall be integrated into the building fire alarm system.

Plans and specifications for fixed extinguishing systems shall be submitted to the AHJ for review. Plans shall include at a minimum the following:

- Device legend
- Uniform scale
- Hazards to be protected
- Location of detection devices
- Location of operating devices
- Layout of piping
- Location of nozzles
- Location of agent bottles.

Fuel Gas (Liquefied Natural Gas LNG/Liquefied Petroleum Gas LPG)

Installation of any fuel gas (LNG or LPG) piping systems shall be designed in accordance with the requirements of the latest edition of NFPA 54, *National Fuel Gas Code* or NFPA 58, *Liquefied Petroleum Gas Code* and International Mechanical Code. Special attention should be given to the installation of monitoring devices when installed in residential or other potentially sensitive areas.

For further information, refer to the TAMU Utilities & Energy Services Design Standard for Piping, Equipment, and Structure Color and Identification

<https://utilities.tamu.edu/wp-content/uploads/2015/01/Piping-Equipment-and-Structure-Color-and-Identification-1.1.pdf>

Gas/Environmental Monitors

Any gas or other type of sensor identified as being required or prudent practice during the design of the project shall be identified and a specification sheet submitted to the AHJ for review. Such devices shall be installed in accordance with the manufacturer's directions.

Key Boxes

All new construction or major renovation to a facility shall include the installation of two key boxes on the exterior location of the facility. Location of the key boxes shall be determined by the AHJ during the design phase. The key boxes shall be a Knox Box® brand key box (or matching local jurisdiction requirements outside of Brazos County). The TAMU standard key box is a Model 4400 series with a hinged door. Large or more complex facilities may require a different/larger box or additional boxes if the design warrants. The TAMU preference is that the boxes be recessed. In general a location near the main or service entrance and in near proximity to the location of the fire command center/fire alarm panel is preferred at a mounting height of 6' above finished floor.

Other requirements for Knox products such as padlocks, gate key switches, etc. shall be determined by the AHJ during the design phase of the project.

For facilities located within Brazos County one box will be keyed to the TAMU University Police Knox System. Facilities being built within the College Station city limits or within the College Station ETJ shall be keyed to the College Station Fire Department key. Facilities being constructed in the Bryan city limits, RELIS Campus, or Bryan ETJ, the primary key shall be on the Bryan Fire Department. Knox Boxes may be ordered directly from the Knox Company – www.knoxbox.com.

It is important to ensure that the appropriate order form/city is identified in order to guarantee that the correct locking system is ordered. Any rekeying will be at the contractor's expense.

Kitchen Hood and Duct Extinguishing Systems

All hood suppression system installations on Texas A&M Campuses shall conform to the requirements of the most recent edition of NFPA 96 *Standard for Ventilation Control and Fire Protection of Commercial Cooking Operations*, NFPA 10 *Standard for the Installation of Portable Fire Extinguishers*, and the following requirements. All systems shall conform to the requirements of UL 300.

For kitchen hood suppression systems – Durable marking shall be placed on the floor to identify the intended location of any cooking appliances that are to be protected by the hood and duct suppression system.

All hood suppression systems shall be integrated into the building fire alarm system.

Plans and specifications for kitchen hood and duct extinguishing systems shall be submitted to the AHJ For review. Plans shall include at a minimum the following:

- Device legend
- Uniform scale
- Hazards to be protected
- Location of detection devices
- Location of operating devices
- Layout of piping
- Location of nozzles
- Location of agent bottles

Post Indicator Valves

All buildings provided with a sprinkler or standpipe system shall utilize a post indicator valve (PIV) on the fire service water main into the building which clearly indicates "Open" or "Closed". PIV's may be wall mounted or free standing. All buildings shall have a separate water supply allowing the domestic and fire service water to be isolated. Post Indicator Valves shall be locked and shall not use tamper switches.

Wall mounted PIV shall be installed so that the center of the valve is located between three and five feet above the grade.

Room Identification/Numbering

The rooms on each floor opening off of either side of a corridor shall be numbered consecutively in a clockwise direction from the primary entrance which shall be 100. If there is more than one main entrance to the building use the one mutually agreed to by the FPC Project Manager and the User Coordinator.

Rooms and spaces not opening off a corridor shall carry the room number of the connecting room with an additional suffix letter (108A, B, C, etc.). Letter clockwise, if more than one room is involved.

Corridors, vestibules and other areas and spaces which have not been assigned numbers by the Campus maybe assigned numbers for completing room finish schedules and for use in reference notes and correspondence. These numbers are not to be considered permanent numbers.

Room numbering shall be coordinated with the various design trades to ensure that number is consistent and included on drawings where applicable (example – coordination with the fire alarm submittals/programming).

All mechanical, electrical, fire riser, fire pump, and fire alarm panel rooms shall be numbered and labeled.

Smoke Management Systems

Where a smoke management system (exhaust or pressurization) is determined to be required the system shall be installed in accordance with NFPA 92, *Standard for Smoke Management Systems* and any other applicable codes or standards.

Standpipe and Hose Valve Systems

Standpipe systems shall be installed in any building 2 or more stories in height. All standpipe systems with a supply line of four inches or greater shall be provided with a 5" Storz fire department connection. **See Fire Department Connections**

All piping shall be adequately supported both horizontally and vertically.

Standpipes shall incorporate a pressure gauge at the highest conditioned level.

Hose valves located in stairwells shall be located on the intermediate landings of stairwells between floors unless otherwise approved by the AHJ.

Provide 2½-inch brass hose valves with a cap and chain. The outlet shall be at an angle between 45 and 135 degrees from the floor. Ensure at least 1" of clearance around handle of valve and provide sufficient clearance for a fire hose to be connected.

Wet standpipes in non-conditioned areas shall incorporate appropriate freeze protection as required/permitted by NFPA 14.

Cabinets in which fire hose connections are installed shall be identified and shall fully open. Valves shall be located to allow ease of connection by fire department personnel during an emergency operations.

Inspection and Acceptance Testing

Unless otherwise noted all fire and life safety systems acceptance testing shall be witnessed by the AHJ in conjunction with the appropriate construction project management team. The contractor shall provide all necessary tools, personnel, and equipment necessary to conduct the acceptance test.

Backflow Preventers

An acceptance test shall be required for any back flow preventers. Copies of documentation of testing and the certification for any fire suppression system shall be provided to the AHJ as a part of the closeout documentation.

Clean Agent Fire Suppression System

An acceptance test of all clean agent fire suppression system installations shall be witnessed by the AHJ. A minimum one week notice shall be provided.

After system installation is completed, the entire system shall be checked out, inspected, and functionally tested by qualified, trained personnel, in accordance with the manufacturers recommended procedures and NFPA 2001. Prior to scheduling a final acceptance of the system, a complete pretest shall be conducted, including an enclosure integrity test.

At time of acceptance the contractor shall be responsible for all necessary tools, personnel, etc. needed to accomplish the acceptance test. This includes inert gas for performing a pneumatic test of the piping for a period of 10 minutes at 40 psi with a loss of pressure not to exceed that which is permitted by code, in addition to a flow test. Any punch list items identified during the final acceptance shall be corrected within 14 calendar days and a retest shall be witnessed by the AHJ. This time period may be accelerated or extended based on the circumstances of the situation.

The system shall be designed, and the enclosure shall be capable of, holding a minimum concentration of 85% of the design concentration for a minimum of 10 minutes. Testing shall be conducted in accordance with NFPA 2001 requirements.

A copy of the enclosure test results shall be submitted to the AHJ after the acceptance test has been completed.

Elevators

Newly installed or retrofitted elevators will be tested by the AHJ. The contractor shall pretest all functions prior to the final acceptance. Final acceptance shall include all fire and life safety functions, including Phase I and Phase II, of the elevator including any devices necessary to conduct such test.

Emergency Light/Exit Signage

The contractor shall provide to EHS at the time of inspection a floor/lighting plan indicating all lighting/signage that is required/installed on emergency power. This will be used to verify all lighting has been installed. All emergency lighting/exit signage shall be tested in accordance with the times specified by the applicable code/standard.

Emergency and Standby Power Systems

An acceptance test of all emergency power system installations shall be witnessed by the AHJ. A minimum of one week notice shall be provided.

Any punch list items identified during the final acceptance shall be corrected within 14 calendar days and a retest shall be witnessed by the AHJ. This time period may be accelerated or extended based on the circumstances of the situation. This time period may be accelerated or extended based on the circumstances of the situation.

Exception: At the discretion of the AHJ this time frame may be accelerated or extended depending on the circumstances of the situation.

A copy of the testing certificate shall be transferred to the AHJ at time of system acceptance.

Acceptance testing shall follow TAMU EHS, FP&C, and NFPA 110 guidelines. The emergency generator acceptance test form is located in Attachment II.

The emergency generator shall undergo a load bank test as required by NFPA 110. The load bank test shall be supervised by FP&C/SSC. Documentation of the test shall be submitted to EHS, FP&C, and the General Contractor.

The emergency generator will be required to perform an emergency power switchover. All emergency circuits will be inspected and tested by EHS and FP&C to ensure correct operation.

Fire Alarm System

Smoke detectors **shall not be installed** in a system until cleanup of all construction trades is complete and final in accordance with NFPA 72. **Any smoke detector heads found to be installed in an active work zone shall be replaced at the contractor's expense.**

The contractor shall have all devices on the system installed and the system pre-tested prior to the scheduled acceptance test that is to be witnessed by the AHJ. Copies of acceptance test forms may be found in the annex section of this document. These completed documents may be used by the contractor and provided to FP&C or SSC as documentation that pre-testing has been completed and that the final acceptance is requested.

Final system acceptance test shall be conducted in accordance with NFPA 72 and this document. All necessary tools, keys, materials, equipment, personnel, etc. needed to accomplish the acceptance test of the fire alarm system and associated equipment shall be provided by the contractor and present at the time of the scheduled acceptance test. Installation and testing shall be inspected and certified by a contractor supplied NICET II (minimum) Technician.

The contractor shall provide at least two (2) copies of shop drawings to be used during the acceptance test. These drawings shall reflect the installed device locations with device address on a floor plan representing the layout of the fire alarm system at the time of acceptance testing. One clean set of installation drawings for verification of location and addresses for the devices shall be placed in the document box after the completion of the acceptance test. A corrected set of As-built drawings shall be provided for installation in the document box within 30 days of the acceptance test. Electronic copies of all as-builts shall be submitted to the project manager and to the AHJ as part of the closeout documentation for the project.

The contractor shall supply an electronic copy of site specific software within 14 calendar days to the TAMU/TAMUS project manager per NFPA 72.

Any deficiencies noted during acceptance testing shall be corrected within 14 calendar days and a retest shall be scheduled for all deficiencies noted if not corrected during the initial acceptance test. Exception - Items requiring correction prior to occupancy shall be completed prior to substantial completion or the issuance of a Certificate of Occupancy.

At a minimum an acceptance test will consist of a functional test of each and every device on the fire detection and alarm system in accordance with the manufactures recommendations.

All fire alarm system acceptance tests shall include verification that trouble, supervisory and fire signals are transmitted to and received at the monitoring station.

Depending on the project management group (i.e. TAMUS Facilities Planning and Construction, SSC Service Solutions, etc.), system acceptance shall be contingent upon approval by EHS and FP&C or SSC Project Manager or Inspector.

Required Documentation/Equipment at Acceptance

- Installation of the fire alarm panel installation tag
- Transfer to EHS a completed NFPA 72 Record of Completion
- Transfer to EHS a completed FML-009 Form
- EHS to provide a copy of the EHS acceptance form to the contractor and to project manager
- O&M Manuals transferred to the TAMU
- Transfer of any special tools or equipment to TAMU
- Sensitivity test provided to EHS and placed in the as-built cabinet.

Required Personnel

Representatives from all trades and groups associated with the installation of the fire alarm system shall be present at the time of the acceptance test. Representatives of the trades shall have the knowledge, skills, and tools necessary to test any devices that are connected to the fire alarm system. Representatives may include, but are not limited to FP&C or designated project management team, TAMU EHS, fire alarm contractor, sprinkler contractor, elevator contractor, HVAC contractor, Facilities Services FLS technicians, general contractor, and electrical contractor for emergency power.

Upon completion of the installation and testing of the system, the contractor shall provide a structured training class to designated university personnel on troubleshooting, maintenance and repair of the installed system as requested. A manufacturer representative shall be present.

The contractor shall provide a price list identifying any special tools and/or equipment required for inspection, testing or maintenance of any installed components. The project manager will determine any equipment needed and provide a list to the contractor. The cost of this equipment shall be included in the contract price.

Fire Dampers/Smoke Dampers

All fire and smoke dampers shall be functionally tested to ensure their operation. Fusible links shall be removed and operation of devices verified. The contractor shall provide a drawing indicating the location of all devices to be used during the inspection/acceptance.

Fire Door Assemblies

All fire doors, whether mechanical or manual, shall be tested for their full functionality. Automatic doors shall be tested by operating any related systems such as activation by the fire alarm system and shall be tested for operation on emergency power if required.

All fire rating labels on fire doors and frames shall be clean, legible, and intact.

Fire Extinguishers

EHS will inspect, inventory, barcode, and attach an inspection tag on all fire extinguishers once they are installed. Any extinguishers requiring maintenance will be brought to the attention of the contractor for extinguisher replacement. No further acceptance testing is necessary.

Fire Extinguisher Cabinets

All fire extinguisher cabinets will be inspected to ensure they are free from damage and fully operational. Any required signage shall be installed prior to the final/life safety inspection.

Fire Hydrants

Upon installation and notification that any new, relocated or modified fire hydrant is ready for acceptance, EHS will verify proper orientation and height of the hydrant, witness a flow test to verify that the valves are open and that the flow is sufficient, check to ensure that caps are sufficiently lubricated and secured to the hydrant and affix a tag with the assigned hydrant number. EHS will take and record readings of the static and residual pressures, along with a pitot pressure. If the flow is acceptable, no additional acceptance will be required by EHS.

Measures will need to be taken by the contractor to ensure that any landscaping will not be damaged by the flowing/flushing of any fire hydrants.

Any hydrant that has been installed but is not in service, has not been flushed to remove all debris, or is taken out of service shall be bagged to indicate such to emergency responders.

Fire Lanes/Aerial Fire Apparatus Access Roads

An acceptance test shall be required for any soft "engineered" fire lane such as a compacted asphalt, gravel, etc. An initial "pretest" will be required by the contractor. This will consist of the contractor having a loaded dump truck drive on the road and make normal turning maneuvers. If the pretest is successful, EHS will arrange for the local municipal fire department to bring a ladder truck as a final acceptance.

Fire Pumps

An acceptance test of all fire pump installations shall be witnessed by the AHJ.

Prior to any scheduled acceptance testing, the suction and discharge piping shall be hydrostatically tested, flushed, and witnessed by the AHJ.

A certificate for flushing and hydrostatic test shall be provided to the AHJ prior to the acceptance test.

A copy of the manufacturer's certified pump test characteristic curve shall be provided to the AHJ for comparison with the results of the acceptance test.

Fire Rated Walls/Partitions

All fire rated wall/partitions will be inspected for compliance with the design documents. Cut sheets for any fire stopping material shall be available for review during the inspection if utilized during the project.

Fire Sprinkler Systems

All fire suppression submittals shall be reviewed by the AHJ and corrected prior to installation. Suppression systems include wet pipe, dry pipe, pre action, clean agent, foam, and deluge sprinkler systems.

All fire suppression system piping shall be inspected during overhead inspections and prior to ceiling cover up.

All underground piping shall be flushed in accordance with NFPA 13 and meet the required GPM flow rates. The AHJ shall witness the flushing and shall inspect all piping prior to cover-up or burying.

Prior to sprinkler heads being added, all above ground sprinkler piping shall be flushed. Flushing of all underground and above ground piping shall be conducting using a minimum 2" hose or piping (or as large as the type of material allows). The contractor shall provide documentation of the flush.

All fire sprinkler piping, to include underground piping, FDC piping, backflow preventers and aboveground piping shall be hydrostatically pressure tested in accordance with NFPA 13 and witnessed by AHJ, FP&C, and the contractor. All sprinkler heads shall be in place (this applies to air leakage testing on dry pipe and pre-action systems). Hydrostatic pressure tests shall include both wet pipe, dry pipe, and pre-action sprinkler systems. Dry pipe and pre-action sprinkler systems shall also be tested with air only at 40 psi for 24 hours. Access to visually inspect all piping shall be provided during the hydrostatic test.

Required Documentation includes the Texas Department of Insurance Aboveground and Underground certification papers (See Attachments VIII and IX). Forms shall be completed by the contractor and signed by all representative parties. Forms shall be submitted to the AHJ and FPC.

Additional required documents include a certified microbial test report of the water supply, backflow preventer forward flow test documents and official backflow certification form from the manufacturer.

All above ground, overhead sprinkler piping shall be inspected and deemed complete and approved prior to cover up. After system installation approval, the official above ground hydrostatic pressure test shall be conducted.

Where any cut in sprinkler piping is made, the disk (coupon) shall be attached to the pipe at the point of the cut and visible for inspection by the AHJ.

Where concealed sprinklers are installed in a building, the cover plates shall not be installed until the ceiling has been installed in those areas and the AHJ has inspected the heads for proper deflector placement in relation to the escutcheon and ceiling.

Any sprinkler head found to have paint or other foreign material of any type or amount shall be replaced. Exception: With approval by the AHJ foreign material that can be easily removed, such as dust, may be carefully removed without having to replace the sprinkler.

As required by the Texas State Fire Marshal's office, the original system installation tag shall be attached to the main system riser and available for inspection at time of system acceptance.

The final functional test shall be considered satisfactorily complete when all valves and switches perform in accordance with the Contractor's approved shop drawings and the following test procedures:

- Operate all control valves to verify proper operation of the valve and associated tamper switch.
- Operate all test connections to verify water flow switch operation.
- Dry-Pipe Valve Operation: Operate the dry system inspector's test connection. Record the following information on the Contractor's Material and Test Certificate during the valve operational test:
 - Time for valve to operate
 - Time to receive water at inspector's test connection
 - Static supply water pressure
 - System air pressure
 - Air pressure at valve release - The inspector's test connection shall receive water within 60 seconds of its operation.

Fixed Extinguishing Systems

An acceptance test of all fixed extinguishing system installations shall be witnessed by the AHJ.

The contractor shall be responsible for all necessary tools, personnel, etc. needed to accomplish the acceptance test. This includes inert gas for performing a flow test of system piping.

Fuel Gas (Liquefied Natural Gas LNG/Liquefied Petroleum Gas LPG)

Installation of any fuel gas (LNG or LPG) systems shall be tested in accordance with the requirements of the latest edition of NFPA 54 *National Fuel Gas Code* or NFPA 58 *Liquefied Petroleum Gas Code*. Documentation of all tests shall be provided to the AHJ (See State Fire Marshal Directive - Annex B).

Any monitoring equipment shall be tested in accordance with the manufacturer's directions. The AHJ shall be notified of any testing.

Gas/Environmental Monitors

Any gas or other type of sensor installed as a safety measure shall be tested in accordance with the manufacturer's directions. Documentation of such testing shall be proved to the AHJ as part of the FLS closeout documentation.

Kitchen Hood and Duct Extinguishing Systems

All hood and duct extinguishing systems shall be tested by conducting a full test of all components of the hood system. The contractor shall provide any required gas canisters for the test. Balloons will not be acceptable as a test method. All components of the system shall be tested including the operation of cutting the fusible link as well as operation of the manual device.

The contractor shall provide a diagrammatic layout of the equipment to be installed along with the location of the suppression nozzles for verification of proper location installation.

Key Boxes

EHS will inspect all key boxes upon final installation. If deemed acceptable, EHS will coordinate, thru TAMU Building Access, obtaining a complete set of keys/access cards for the facility and the transfer of the keys and locking of the box with the appropriate police and/or fire department. No further acceptance testing is necessary.

Post Indicator Valves

The PIV for the sprinkler system shall be locked while the building is under construction. Once the building is turned over to the user, the contractor's lock shall be removed and Facilities Services FLS will install a TAMU lock. The PIV shall be tested by fully opening and closing the valve and ensuring that the indicator panel is appropriately adjusted to provide a clear indication as to the status.

Smoke Management/Control Systems

All smoke management systems (stairwell pressurization, smoke evacuation, etc.) shall be tested to meet the design requirement as determined by the Engineer of Record. Testing shall include a functional test of each component and their interconnections with other systems. Force readings shall be taken and recorded for any doors in areas affected by the smoke management/control systems.

Standpipe Systems and Hose Valve Systems

Once installed and tested, standpipe systems shall be flowed at the most hydraulically remote location to flush the system.

Annex A Texas A&M University Fire Alarm System Design and Installation Standard

The following information shall serve as a design and installations standard for fire alarm systems installed on the Texas A&M University (TAMU) campuses, the TAMUS RELLIS Campus, and Texas A&M University Health Science Center Facilities located throughout the state of Texas.

General Information

The contractor shall perform all work necessary to design, install, and test any new fire alarm system installation. This includes, but is not limited to, all labor, materials, and commissioning.

The complete installation shall conform to the applicable sections of the most current edition of the National Fire Protection Association (NFPA) codes and standards. In addition, the design shall conform to the American Disabilities Act (ADA), the National Electrical Code, the International Building Code, the Texas Accessibility Standards Act (TAS), where items are not addressed by NFPA 1 and NFPA 101, and these specifications.

All fire alarm system retrofit projects shall include a field survey of the facility to determine device locations and system layout. The walkthroughs should include a member from the TAMU/TAMUS project management group, the design team, and EHS.

General Design Guidelines

All components of the fire alarm system shall be able to interface completely with the fiber network reporting system used by Texas A&M University while maintaining a UL listing (See Annex B).

All new fire alarm systems installations at Texas A&M University shall utilize the following general guidelines as a basis for the system layout. These general guidelines are for fully sprinklered buildings. These are general guidelines and may vary as determined by the AHJ during walkthrough and plan review sessions.

Smoke Detectors

- Shall be photoelectric unless specified by the AHJ
- Shall be installed in the following locations:
 - All corridors and common use spaces such as lobbies, reception areas, etc.
 - Intermediate or remote areas where smoke would need to penetrate multiple doors to reach a smoke detector in a corridor or common area
 - Conditioned electrical and mechanical rooms
 - Storage rooms
- Smoke detectors shall not be installed in
 - Custodial closets
 - Non-conditioned pump rooms

Heat Detectors shall be installed in break rooms/kitchens and locations as appropriate.

Manual pull stations shall be installed at the following locations:

- Every level at every enclosed or exterior exit
- In corridors where travel distance to a pull station exceeds 200 feet
- Every horizontal exit as defined by NFPA 101, *Life Safety Code*®

Specific Design Specifications

High-rise buildings

- Provide a fireman's phone system and boxes for phone
- Provide an unsupervised printer that shall record all system events and time of the event
- All high-rise buildings shall be programmed for general alarm activation (not high-rise mode).

Residence Halls

- Detectors in resident hall rooms shall be smoke detectors

- Activation of the heat/smoke detector shall sound a local and general alarm unless otherwise approved/directed by the AHJ
- Activation of a general alarm shall activate sounder bases in all resident hall rooms
- Notification appliances/devices shall incorporate the 520 hz frequency as required by NFPA 72

Animal housing areas

- Chimes or speaker in a similar frequency range may be installed in animal housing areas (system designer should verify with user to determine if and when this might be necessary)

Instructions to Contractors

- The contractor shall provide three (3) copies of detailed plans, and specifications as enumerated in Appendix A for review and approval prior to installation.
- The contractor shall get clarification from the AHJ and approval from the University Project Manager when a question or discrepancy arises.
- Upon completion of the installation and testing of the system, the contractor shall provide a structured training class to designated university personnel on troubleshooting, maintenance and repair of the installed system as requested. A manufacturer representative shall be present.
- Contractor shall contact the Communications Center and the Building Proctor/Facility Coordinator before work is started each day to advise they are working in the facility.
- The contractor shall provide a price list identifying any special tools and/or equipment required for inspection, testing or maintenance of any installed components. The project manager will determine any equipment needed and provide a list to the contractor. The cost of this equipment shall be included in the contract price.
- The contractor shall provide within fourteen (14) calendar days of the acceptance test one (1) electronic copy in AutoCAD 2004 or later version on a CD, and three (3) hard copies of As-Built drawings reflecting any and all changes noted during acceptance testing. These drawing should be complete and detailed as enumerated in Appendix A. The drawings shall accurately reflect the installed system.

Quality Control Assurance

- All components of the fire alarm system shall be products of an Underwriters Laboratories Inc. listed fire alarm manufacturer, and shall bear the UL label. Partial listing **shall not** be acceptable.
- All components of the fire alarm systems shall use the most current technology available.
- Only new parts shall be installed at the time of initial installation and to repair the system during the warranty period. No reconditioned parts shall be used.
- All devices shall be tested and certified that they meet or exceed the "Service Life Expectancy Rating" as outlined by UL and NFPA.
- The equipment and installation supervision furnished under this specification is to be provided by a manufacturer who has been engaged in production of this type of equipment (software-driven) for at least 5 years and has a fully-equipped service organization within 150 miles of the installation site. Service shall be provided within 24 hours of problem notification.
- All conductors shall be uniformly and consistently color-coded and labeled throughout.
- All power supplies connected to the system shall have transient protection in accordance with UL 864.
- Detectors **shall not** be installed until cleanup of all construction trades is complete as required by NFPA 72. Any detectors found installed prior to this cleanup shall be replaced at the contractor's expense.
- Conduits shall not be filled to more than 40% capacity. Conduits shall have a J-box no further than 100 feet or at each 90° turn, whichever occurs first. All J-boxes shall be painted red or have the letters FA in red on the cover. Where a J-box at every 90° turn may be considered excessive, the contractor should get direction from the TAMU/TAMUS project manager before omitting any J-box. All J-boxes shall be easily accessible.
- The contractor shall identify and label circuit breakers on main and emergency power supplies and identify these electrical panel location(s) and breaker number(s) inside the Fire Alarm Control Panel (FACP) in accordance with NFPA 72. Any breaker associated with the FAS shall be painted red.

Design Specifications

General Requirements

- Panels shall be easily expandable and upgradeable
- Unless otherwise approved by the AHJ, the FACP shall have software that will enable the system to be intelligent
- All Fire Alarm Systems (FAS) shall be equipped with voice notification and have public address capability unless otherwise approved by the AHJ
- Provide software that:

- Is password protected
 - Offers computer driven device calibration test and reporting features, by device, loop, or system
 - Latches all Alarm, Trouble, and Supervisory signals, unless otherwise requested by AHJ
- Power for the FAS (FACP and all components) shall be from one electrical panel unless approved by the AHJ.
- Wiring shall be class B wiring unless specific design conditions warrant.
- Furnish and install “surge protection devices” on all circuits that extend beyond the main building (i.e. walkways, aerial, or underground methods):
 - Surge protection devices shall be located as close as practical to the point where circuits leave the building.
 - Surge protection devices shall have a line to line response time of less than one nanosecond capable of accepting 2000 amps to earth.
 - Surge protection devices shall comply with UL 497 B and NEC 760.
- All addressable loops shall have loop isolation protection devices to maintain partial fire alarm system integrity should a fault occur. A loop isolation device shall not exceed a maximum of 20 devices.
- A maximum of 80% capacity of initiating devices is allowed per loop.
- The fire alarm system shall use closed loop initiating device circuits with individual zone (device) supervision, individual notification appliance supervision, and primary and standby power supervision.
- Each device shall be labeled and the label designations shall be accurate and consistent with those on the prints, the annunciators, the points list, and message displays.
- All devices, panels and auxiliary panels shall be mounted in easily accessible locations. The top of all panels shall be mounted no more than six (6) feet above finished floor.
- The FACP will consist of a control center utilizing state of the art electronics with microprocessor-based technology and a minimum of four zone (loop) capability. The FACP shall be software controlled with the capability of owner programming. The installer shall supply all programming data (complete program, data list) software and all updates to the software. Software media shall be Windows compatible using the most current version.
- The FACP shall have software capable of supervising Air Handler Unit (AHU) shutdown.
- The FACP shall have an audible device and separate LED’s indicating ALARM, TROUBLE and SUPERVISORY conditions with each having a separate and distinguishable sound. The FACP shall have a backlit LCD display of at least three lines of at least 40 characters each. An indication of POWER, TROUBLE, and PARTIAL DISABLE shall be included as an LED output.
- The FACP equipment cabinet shall be of sufficient size to accommodate the main fire panel, main and standby power supplies (battery), cable and wire harnesses and any auxiliary relays. Batteries shall have the manufacturers date displayed or noted on the battery.
- Remote annunciators (if installed) shall have the same capabilities as the FACP in all respects unless otherwise directed by the AHJ.
- Where detection devices are installed above ceilings a remote indicator shall be installed at the ceiling level to identify the location of the device. Where installing a remote indicator is not possible signage indicating the type and address of the device(s) shall be permanently attached to the ceiling grid below the device location.
- There shall be a separate box located next to the FACP of sufficient size to accommodate spare detectors and paperwork (16” x 16” x 6” min.). This box shall be of matching color with the FACP cabinet and shall be keyed the same as the FACP.
- Printer interface modules shall be installed in all systems.

Programming Requirements

- Provide a “Drill Function” on the panel that is easily identifiable and only initiates notification appliances on all floors.
- Provide a Programmable “Bypass” function for:
 - AHU shut down
 - Elevator recall

- Stairwell pressurization fans
- Notification appliances
- Alarm verification.
- Provides for all controlled systems to “auto reset,” (i.e., AHUs and elevators)
- Provides for all system devices to be restorable from the FACP.

Initiating Devices

All water flow switches shall be time adjustable complying with NFPA 72. Activation time should be approximately 30 - 45 seconds.

Valve tamper switches shall comply with NFPA 72. A supervisory condition shall result from a tamper switch activation.

Beam detectors shall:

- Comply with UL 268
- Be 24vdc operation
- Have automatic contamination compensation

Detector bases shall:

- Be low profile, surface, or flush mounted into a standard four inch square electrical box
- Be able to accept heat, ionization, or photoelectric devices interchangeably

Smoke detectors shall:

- Have an LED that flashes during normal operation
 - Ionization detectors shall be dual chamber and be scaled against rear airflow
 - Be self-adjusting for airborne contaminants
 - Have clear, distinct visual alarm indication
 - Be mounted in easily accessible locations
 - Be programmed to have alarm verification

Duct detectors shall:

- Report to FACP as a supervisory alarm
- Be of the photoelectric type
- Have clear, distinct visual power and alarm indications
- Be programmed to have alarm verification
- Have extended visual indicators if mounted above ceiling located as close to duct detector as possible

Thermal (Heat) detectors shall:

- Be of the dual element, self-restoring type
- Have a flashing LED for normal operation
- Have clear, distinct visual alarm indication

Manual pull stations shall:

- Be cast aluminum or high impact plastic and be red in color
- Be zoned separately if not addressable
- Provide a clear visual indication when activated
- Not require consumable parts to reset to normal condition
- Be double action.

Notification Appliances

Audible devices:

- Shall be tapped to an adequate wattage capable of achieving the minimum code required dB readings throughout the facility
- Shall be tapped at the highest wattage in all mechanical rooms
- May be ceiling mounted speakers or combination devices where permitted to be installed by code

Visual devices:

- May be ceiling mounted or combination devices where permitted by code

Installation, Testing, and Acceptance

The contractor shall have all devices on the system installed and the system pre-tested prior to the scheduled acceptance test.

The contractor shall provide all tools, labor, and materials required for all installation start-up tests, including a qualified technician to conduct the test.

Installation and testing shall be inspected and certified by a contractor supplied NICET II (minimum) Technician.

System acceptance test shall be conducted in accordance with NFPA 72.

Any deficiencies noted during acceptance testing shall be corrected within 14 calendar days and a retest shall be scheduled for all deficiencies noted if not corrected during the acceptance test.

Depending on the project management group (i.e. TAMUS FP&C, TAMU Facilities Services, Engineering, Design, and Construction, etc.), system acceptance shall be contingent upon approval by EHS, FP&C, and a Facilities Services representative.

Upon completion of testing, the contractor shall install the proper certification certificates in the FACP and provide a copy of NFPA 72 Record of Completion, the FML-009 Form, and smoke detector sensitivity test to EHS.

The contractor shall provide three (3) copies of drawings to be used during the acceptance test. These drawings shall reflect the installed device locations with device address on a floor plan representing the layout of the fire alarm system at the time of acceptance testing.

The contractor shall supply an electronic copy of site specific software within 14 calendar days to the TAMU/TAMUS project manager per NFPA 72.

Warranty

The system shall be guaranteed to be free from all defects of material and workmanship for a period of one year, effective upon date of system acceptance.

The contractor shall guarantee parts availability for a minimum of five (5) years after installation.

Fire Alarm Design Submittal Requirements

All preliminary and as-built design drawings and supporting documentation shall include: Floor plan drawings, riser diagrams, control unit wiring diagrams, point to point wiring diagrams, and typical wiring diagrams as described herein

- Name of owner and occupant
- Location, including street address
- Device legend
- Date
- Input/output programming matrix
- Licensed Designer Information – Registered Professional Engineer or Alarm Planning Superintendent (APS)
- Battery calculations
- Notification appliance circuit voltage drop calculations
- Floor Plan
 - Floor identification
 - Point of compass
 - Correct graphic scale
 - All walls and doors
 - All partitions extending to within 15 percent of ceiling height
 - Room descriptions
 - Fire alarm device/component locations
 - Signal notification devices
 - Initiation devices
 - Smoke control systems
 - Initiation of automatic extinguishing equipment
 - Doors that unlock or close automatically
 - Zone verification for detection devices
 - Fire/Smoke damper control
 - Fire alarm panel location
 - Fire alarm annunciators
 - Control valves to Fire Protection System
 - Duct smoke detectors
 - Supervisory devices
 - Elevator location
 - Elevator recall system location
 - Location of fire alarm primary power connections
 - Location of monitor/control interfaces to other systems
 - Riser locations
 - Methods for compliance with for survivability (emergency voice systems), where applicable
 - Ceiling height and ceiling construction details
- Fire alarm system riser diagram
 - General arrangement of the system, in building cross-section
 - Number of risers
 - Type and number of circuits in each riser
 - Type and number of fire alarm components/devices on each circuit, on each floor or level
- Control unit wiring diagrams should be provided for all control equipment, power supplies, battery charges, and annunciators and should include the following:
 - Identification of control equipment depicted
 - Location(s) of:
 - All field wiring terminals and terminal identification
 - All indicators and Manual controls, including the full text of all labels
 - All field connections to supervising station signaling equipment, releasing equipment, and fire safety control
 - Typical wiring diagram should be provided for all initiating devices, notification appliances, remote light emitting diodes (LEDs), remote test stations, and end-of-line and power supervisory devices.

Annex B
Texas State Fire Marshal
Gas Directive

**Texas Department of Insurance
STATE FIRE MARSHAL'S OFFICE
AUSTIN, TEXAS**

State Fire Marshal Directive

Pursuant to the authority of Texas Government Code § 417.008, the State Fire Marshal is directing that your agency, or university, take immediate steps to insure that:

1. All master-metered natural gas piping systems owned, operated and controlled by a State Agency or State Higher Education Campus are designed, constructed, maintained and operated in accordance with the Minimum Safety Standards for Natural Gas, 49 Code of Federal Regulations (CFR) Part 192, as required by 16 TAC §8.
2. All interior gas piping in structures and buildings is installed, operated, tested, and repaired in accordance with National Fire Protection Association Fuel Gas Code, NFPA 54. In a single-metered building where the gas meter is located remote from the building, any underground piping from the meter to the point of building entry shall also be in compliance with NFPA 54, *Fuel Gas Code*.
3. A pressure test is completed on all interior gas piping in all buildings containing sleeping facilities by December 31, 2005 and retesting shall be conducted at least every two years after completion of the initial test.
4. A leakage survey shall be completed on all interior gas piping in all buildings not containing sleeping facilities by September 1, 2006. Leakage surveys shall be conducted first on those buildings where the occupancy load is 300 or more people and in those buildings considered to be high-hazard or with multiple gas piping installations or appliances.

Once leakage surveys have been completed in a building, gas piping and appliances shall be installed, tested, repaired, and maintained in accordance with NFPA 54, *Fuel Gas Code*.

5. All underground piping between the gas meter and the building shall be leak surveyed in accordance with 49 CFR 192.723 (b) (2).

Pressure Testing Criteria: A pressure test to determine if the natural gas piping in each facility will hold at least normal operating pressure shall be performed as follows:

1. For systems on which the normal operating pressure is less than 0.5 pounds per square inch gauge (psig), the test pressure shall be 5.0 psig and the time interval shall be 30 minutes.
2. For systems on which the normal operating pressure is 0.5 psig to 4.9 psig, the test pressure shall be 1.5 times the normal operating pressure or 5.0 psig, whichever is greater, and the time interval shall be 30 minutes.
3. A pressure test using normal operating pressure shall be utilized only on systems operating at 5.0 psig or greater, and the time interval shall be one hour.

Any interior piping failing the pressure test shall be repaired and retested or the piping shall be disconnected from the gas supply.

The testing shall be conducted by:

1. A licensed plumber;
2. A qualified employee or agent of the facility who is regularly employed as or acting as a maintenance person or maintenance engineer; or
3. A person exempt from the plumbing license law as provided in Texas Civil Statutes, Article 6243-101, §3. Documentation of training and experience for these exempt personnel shall be maintained by the agency.

Equivalent methods of compliance that meet the intent of this directive may be acceptable. Requests are to be submitted under the signature of the Executive Director of the Agency or University President to the State Fire Marshal for approval.

All facilities should take immediate action to insure compliance. All facilities should be in compliance no later than the dates listed herein. Documentation of compliance shall be maintained in the facility safety department and be available for inspection by the State Fire Marshal, Railroad Commission, or other state officials.

This directive does not release any facility from requirements of the Texas Railroad Commission or Federal law or regulations.

Any questions can be directed to Wayne Smith, Director of Fire Safety Inspections, State Fire Marshal's Office, Texas Department of Insurance. Mr. Smith can be reached at (512) 305-7911 or by E-mail at wayne.smith@tdi.state.tx.us.

Issued February 4, 2005, by the authority of the State Fire Marshal.

A handwritten signature in black ink that reads "Paul W. Maldonado". The signature is written in a cursive style with a long horizontal flourish at the end.

Paul W. Maldonado
State Fire Marshal

Annex C
Example Photographs



Photo 1 – Fire Wall Label Example #1

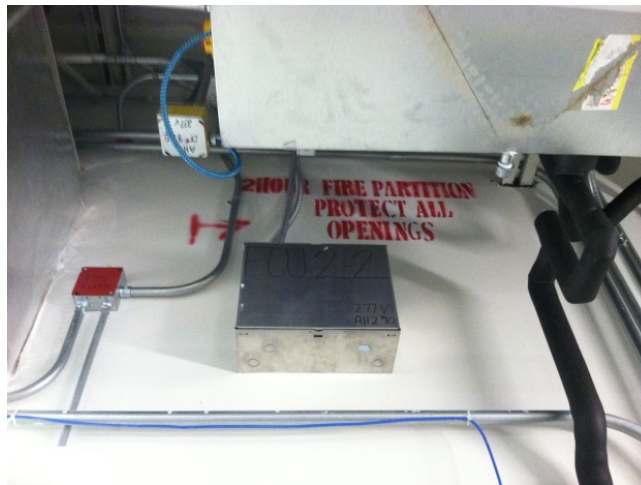

Photo 2 – Fire Wall Label Example #2



Photo 3 – Floor Control Valve Identification



Photo 4 – Remote Standpipe/Sprinkler Identification



Photo 5 – Fire Department Connection Sign

Annex D
College Station Fire Department
Construction and Development Guide

Note: Only for information and guidance where referenced elsewhere in this document



College Station Fire Department

Fire Prevention Division



Construction & Development Guide

Revised Jan 2016

Preface

This guide is intended to assist architects and developers in preparing plans for submittal to the City of College Station for review. This guide deals mainly with the construction requirements of the College Station Fire Department, and does not address the requirements of other departments within the city. The items addressed are requirements found in the following codes: the 2015 International Fire Code, 2015 International Building Code, and National Fire Codes published by the National Fire Protection Association, 2015 Life Safety Code, Local Codes, City Ordinances, and Policies. Local Amendments to the adopted codes can be found in the City Code of Ordinances chapter 6.

In reviewing plans for new development the two main concerns of the fire department are *Access* and *Water Supply* for firefighting purposes. These two concerns are examined in detail when an initial site plan is submitted for approval, and again when construction plans are being reviewed prior to issuance of a building permit. A set of standard comments is found in (Appendix B-1) which you should review each time you plan a development and prior to submitting a set of construction plans for review.

In reviewing plans for remodeling or new construction projects, the Fire Department is concerned with several major items. These items are checked utilizing the above-mentioned codes for reference. The codes used will depend on the type of facility being constructed. **If two different codes reference the same subject then the more stringent code shall apply.**

Please prepare your plans with the knowledge that our ultimate goal is to ensure life safety. While every effort is made to be very thorough in the plan review process, there is a possibility something may be overlooked during the plan review process. If this occurs the problems may be noted during one of the site inspections, or at the final inspection for the Certificate of Occupancy. Compliance may be required prior to the issuance of the Certificate of Occupancy. Therefore, if you feel some aspect of your project requires special attention, or you have specific questions, please bring this to our attention as soon as possible. We prefer to utilize the plan review process as a positive time to review important issues rather than trying to correct costly problems at the end of a construction project.

We encourage pre-development consultations to discuss projects prior to plans being completed. Please contact the Development Services Office at (979)764-3570 or our office to schedule an appointment or to ask a question. You may contact a member of the Fire Prevention Division by mail or phone at the following location.

College Station Fire Department
Fire Prevention Division
300 Krenek Tap Road
College Station, Texas 77842
(979) 764-3705

Table of Contents

<u>Preface</u>	<u>2</u>
<u>Table of Contents</u>	<u>3</u>
<u>Permits required by the Fire Marshal</u>	<u>4</u>
<u>Construction Checklist</u>	<u>5--10</u>
<u>Water Supplies</u>	<u>11</u>
<u>Fire Sprinkler and Alarm System Requirements</u>	<u>11--14</u>
<u>Kitchen Fire Extinguishing Systems</u>	<u>14</u>
<u>Appendix A</u>	<u>15</u>
<u>Fire Hydrant Installation Detail</u>	<u>A-1</u>
<u>Fire Hydrant Bollard Detail</u>	<u>A-2</u>
<u>Approved Access Turnaround</u>	<u>A-3</u>
<u>Turning Radius Specifications</u>	<u>A-4</u>
<u>Fire Lane Markings</u>	<u>A-5 & A-6</u>
<u>Appendix B</u>	<u>23</u>
<u>Standard Comments</u>	<u>B-1</u>
<u>Plans Submittal Checklist For New Construction</u>	<u>B-2</u>
<u>Plans Submittal Checklist For Remodeled Tenant Space</u>	<u>B-3</u>
<u>Addressing Requirements</u>	<u>B-4</u>

Permits required by the Fire Marshal's Office

In order to receive a permit for work within the City of College Station plans must be submitted through eTRAKIT for review and approval. Permits for work include but not limited to:

1. Fire alarm.
2. Fire sprinkler.
3. Fire sprinkler underground lines.
4. Commercial cooking hood suppression system.
5. Underground liquid petroleum tanks/lines at service stations.

The Fire Marshal or a designee must approve all plans and a permit issued before any work can start. Failure to adhere to these guidelines may result in a stop work order, warning issued or citations issued. The permit and approved plans must be onsite at all times the work is being performed.

COLLEGE STATION FIRE DEPARTMENT **CONSTRUCTION CHECKLIST**

This checklist references items that are critical to the plan review process and the eventual outcome of the Fire Final Certificate of Occupancy (C.O.) Inspection. This is a partial list only and should not be construed to be all inclusive of the Fire, Building, and City codes. The developer or his representative should be well versed in all applicable codes.

Note: All items within this checklist may or may not apply to your specific development.

Plan Review Process

(See Appendix B-2, B-3)

Plans approved by all applicable city agencies

Engineering will approve fire hydrant locations. The water system is required to show existing and proposed water mains, main size and fire hydrant locations with distances from the proposed building.

Building permits are issued by the College Station Building Department.

Address Requirements

(See Appendix B-4)

- ' Each property within the College Station City limits must be numbered in compliance with city ordinance, Chapter 6 Section 1 (B) (18/19) City of College Code of Ordinances. The Building Official shall designate the official number to be located on the structure. Each structure on the premises that is not an accessory structure shall also be numbered in a conspicuous manner. A person may request an official number designation by submitting the legal description of the property to the Building Official.
- ' Assigned addresses shall be posted on construction sites in a highly visible location facing the addressed street. The address shall be in place during the construction period of the project. Numbers shall be no less than four (4) inches tall and have no less than one half (½) inch stroke on a contrasting background.
- ' The owner or his representative shall provide the Fire Department with emergency phone numbers prior to any site construction.

Fire Hydrants

(See Appendix A-1)

- ' The College Station Development Engineer shall approve locations of fire hydrant(s).
- ' Fire hydrants must be serviceable (wet), accepted by the City Engineer and accessible during all phases of combustible construction on the project.
- ' The calculated fire flow projections of fire hydrants and fire mains shall be submitted to the College Station Development Engineer for approval.
- ' Fire hydrants shall face the proper direction. The steamer connection (large 4½ inch connection) shall face the drive surface. Indicate direction on plans. All caps shall be in place on hydrants. *Refer questions on hydrant directions to the College Station Fire Marshal.*
- ' The College Station Development Engineer, if required, shall approve bollard protection. (See Appendix A-2)
- ' Proper grading and elevation around hydrant must be provided at the time of final inspection.
- ' Vegetation and landscaping shall be placed in a manner as not to obstruct or impede a fire hydrant from view or use.

Fire Lanes

- ' Fire lanes are to be marked in accordance with city ordinance specifications, Chapter 6 Section 1 (B) (14) City of College Station Code of Ordinances. (See Appendix A-5, A-6)
- ' The College Station Development Engineer shall approve turning radius requirements. (See Appendix A-4)
- ' Design of fire department turnarounds must be provided to and approved by the College Station Development Engineer. (See Appendix A-3)
- ' The minimum access roadway width of twenty (20) feet and clearance height of fourteen (14) feet shall be provided on any designated fire lane. Buildings with eaves exceeding (30) feet in height shall have a minimum access roadway width of (26) feet located within a minimum of (15) feet and a maximum of (30) feet from the building, and shall be positioned parallel to one entire side of the building.

- ‘ Any deviation from the Unified Development Ordinance’s surface specifications, require prior approval from the College Station Fire Marshal and the College Station Development Engineer. The alternative surface shall meet current College Station Development Engineer specifications for all weather surfaces.

Knox Box System

- ‘ The Fire Marshal requires all commercial properties to install a Knox Box System when on-site security makes emergency access difficult, International Fire Code Section 506. Contact the College Station Fire Department Fire Prevention Division for order forms and key installation.
- ‘ The Fire Marshal requires all properties equipped with a sprinkler system to have Knox FDC plugs in the FDC connection.
- ‘ Contact the Fire Prevention Division for placement instructions prior to installation.
- ‘ Keys installed in the Knox Box shall be clearly labeled.
- ‘ Knox Box identification stickers for each entrance door are highly recommended.

Fire Extinguishers

Note: Extinguisher requirement may change with occupancy/ hazard classification.

- ‘ Minimum 2A-10BC rating (approximately 5 lb.) required. One extinguisher is required for every three thousand square feet, (**per floor**). Maximum travel distance to an extinguisher in light hazard occupancy is fifty (50) feet. ****Travel distance is seventy-five (75) feet if occupancy is protected by a fire sprinkler system**.**
- ‘ Extinguisher(s) mounted in a visible and accessible location (in path of egress if possible).
- ‘ Extinguisher(s) mounted no closer than four (4) inches to the finished floor and no higher than five (5) feet above the finished floor to the top of the extinguisher.
- ‘ All fire extinguishers are required to have a current inspection tag in place showing an inspection was performed within the past year. A state licensed company must perform this inspection. New extinguishers may have the receipt of purchase attached instead of an inspection tag for the first year only.

Fire Protection Equipment

(Where applicable)

Note: All fire protection systems shall meet the applicable N.F.P.A. standard.

- ' Alarm panels are to be accessible and properly labeled for different zones. Alarm panel locations shall be approved by the Fire Marshal's Office.
- ' Fire department connection shall be located no more than one hundred (100) feet from a fire hydrant.
- ' Fire department connections shall be unobstructed at all times.
- ' Sprinkler system shall be tested by a member of the College Station Fire Marshal Office and monitored prior to any inventory being stored in the building. A copy of the monitoring contract shall be sent to the College Station Fire Department Fire Prevention Division.
- ' Sprinkler system controls and water flow switches are required to be monitored by an approved monitoring company.
- ' Sprinkler heads are clean of any foreign material, properly spaced, unobstructed and all concealed spaces properly protected.
- ' No storage or shelving closer than eighteen (18) inches of the bottom plane of sprinkler heads.

Signs and Labeling

- ' All sprinkler valves; shutoffs, etc. are required to be labeled in accordance with N.F.P.A. 13 guidelines.
- ' All fire alarms systems and zones are to be properly labeled in accordance with N.F.P.A. 72. (Zone map is required)
- ' Illuminated exit signs are installed in accordance with building plans, for additional exit requirements. (See Appendix A-7)
- ' Fire lanes are to be properly marked as required.
- ' "No Smoking" signs are posted in areas where readily combustible or flammable materials are present.
- ' N.F.P.A. 704 placards will be provided where required (N.F.P.A. 704, Section 1-2.1).
- ' "This door to remained unlocked when building is occupied" signs are posted when required by code.
- ' Occupancy card issued by Building Official is posted in all assembly occupancies.

Site Maintenance during Construction

- ' Exits and exit corridors are unobstructed during all phases of construction.
- ' Adequate removal of construction debris shall be performed during all phases of construction.
- ' Compressed gas cylinders are to be secured and properly marked.
- ' Access roads, fire lanes and fire hydrants are to remain unobstructed at all times during construction.
- ' Standpipe systems in high-rise structures shall be maintained in accordance with International Fire Codes and NFPA 14 as the buildings are being constructed.

System Tests

A minimum of twenty-four hours advance scheduling and advance payment of testing fee is required for the following tests. Written certification will be provided.

Note: Test fee shall be paid in the Building Department.

- ' Alarm test
- ' Carbon dioxide and dry chemical systems
- ' Smoke detection systems
- ' Fire sprinkler and standpipe systems (200 psi hydrostatic test for new system, 150 psi hydrostatic test for remodeled or an addition to existing systems).
- ' Underground fuel tank and/or line test
- ' Underground fire lines
- ' Commercial kitchen hood extinguishing system test

Inspection Request Sequence

- ' Development checklist is completed as applicable.
- ' Ensure all "*special permits*" have been finalized and all acceptance tests have been passed prior to requesting a Final Fire Inspection. **Note:** Contact College Station Fire Department Fire Prevention Division for all fire inspections.
- ' Building shall be unlocked so the inspector can gain entry to complete the building inspection unless prior arrangements have been made.
- ' Electrical power is on to the structure and all emergency back-up units are fully charged.
- ' The building permit and an approved set of construction plans are to be on-site during all inspections.
- ' The Certificate of Occupancy is issued by the Building Official after all inspections are satisfactorily completed.

Projects With Special Considerations

Contact the Development Coordinator in Development Services or the College Station Fire Marshal for assistance and scheduling of a pre-development meeting.

- ' High-rise buildings
- ' Large malls or shopping centers
- ' Large warehouses
- ' Apartment complexes
- ' Projects involving large quantities or storage and/or use of hazardous materials and/or flammable liquids
- ' Projects involving a hazardous manufacturing process or procedure

All plans for new construction shall be submitted through the College Station Development Coordinator who will be responsible for distributing the plans to the proper city departments for their review.

Water Supplies

Public fire hydrants shall be installed in single-family and duplex zoning districts at such locations that no part of any structure shall be more than five hundred (500) feet from a fire hydrant as measured along the right-of-way of a public street as the fire hose is laid off the fire truck. Chapter 6 Section 1 (B) (22) 507.5.2 City of College Station Code of Ordinances

Public fire hydrants shall be installed in districts other than single-family and duplex zoning districts at such locations that no part of any structure, aboveground tanks or fueling stations shall be more than three hundred (300) feet from a fire hydrant as measured along the right-of-way of a public street or along an approved fire lane as the fire hose is laid off the fire truck. The installation of public fire hydrants in such districts may be deferred and required as a condition of the building permit for structures. Chapter 6 Section 1 (B) (23) 507.5.3 City of College Station Code of Ordinances

Fire hydrants shall be tested prior to any construction. The College Station Development Engineer shall approve hydrant locations. Fire hydrant access shall not be obstructed or impeded at any time.

Underground fire lines must be hydro tested and witnessed by a member of the College Station Fire Marshal Office prior to cover-up.

All other regulations regarding water distribution should be directed to the College Station Development Engineer.

Automatic Fire Sprinkler System Requirements

Fire sprinkler systems shall meet the criteria of the 2015 International Fire Code, 2015 International Building Code and all applicable provisions of N.F.P.A. 13, 13-R, and 13-D, 2013. Plan submittal with required approval and permits must be secured through the College Station Fire Department through eTRACKiT. Permits must be obtained before any work can begin. All tests must be prepaid at the College Station Planning and Development Services. All system inspections and tests should be scheduled through the College Station Fire Marshal Office.

Alarm Requirements

Alarm systems must meet the requirements of 2015 International Fire Code, applicable amendments in the City code of ordinances, 2015 International Building Code and amendments, the applicable provisions of the 2013 N.F.P.A. 72 and the 2015 Life Safety Code. Plans must be submitted through eTRAKiT to the College Station Fire Marshal office and after review a permit will be issued. Permits must be obtained before any work can begin. All system inspections and tests should be scheduled through the College Station Fire Marshal Office.

Planning

Drawings are required and must be submitted through eTRAKiT to the College Station Fire Marshal's Office, which include, but are not limited to the following items:

1. Engineer's seal on plans.
2. Piping locations.
3. Pipe sizes.
4. Hanger locations and hanger details.
5. Head locations and details (walls and other obstructions).
6. Riser specifications including valves, gauges, and fire department connection(s).
7. Hydraulic calculations
8. Building classification (construction type).
9. Hazardous storage and precautions taken for accidental spills.
10. Double check valves shall be installed in accordance with College Station Engineering Division specifications and documentation of testing shall be provided to the Fire Marshal prior to acceptance of the sprinkler system.

Sprinkler system plans shall be submitted through eTRAKiT at the same time as the building plans. Any concerns regarding the drawings will be addressed and sent back with that set of drawings. If you have any questions regarding the fire sprinkler system please contact the Fire Marshal's Office.

Testing

Newly installed sprinkler systems require a two (2) hour two hundred (200) psi hydrostatic test. The testing procedure for existing sprinkler systems is a two (2) hour one hundred fifty (150) psi hydrostatic test.

If an existing system is extensively altered, the system shall be re-tested. The decision to re-test a system shall be determined by the College Station Fire Marshal or designee on a case-by-case basis. Existing hydraulically calculated systems shall be recalculated when the addition of one or more sprinkler heads is required. (Calculations shall be provided through eTRAKiT for review)

All sprinkler system valves shall be properly marked in accordance with N.F.P.A. 13.

The hydrostatic acceptance test shall be witnessed and approved by a member of the College Station Fire Marshal's office. The sprinkler system test fee is indicated on the "Inspection/ Test request" located in Appendix A-8. The permit fee shall be paid at the College Station Building Department. If the system does not pass an additional test fee is required.

Sprinkler piping and hangers shall not be covered and/or concealed by any means prior to being inspected and approved by the College Station Fire Marshal Office. ***This includes drop grid style ceilings***

A member of the College Station Fire Marshal's Office shall witness a hydrostatic test of the underground supply line(s) to the sprinkler riser.

Additional Information

In all structures, except single-family or duplex dwellings protected by an automatic fire sprinkler system as a requirement, an electronic water flow alarm shall be provided as a means of supervising the system. All required systems designed in accordance with N.F.P.A. 13 or 13-R, except in single-family or duplex dwellings, shall be constantly monitored by a licensed alarm company. Any changes that must be made to update the system shall be at the owner's expense. All alarm systems shall be approved by and tested by the Fire Marshal or his designee to ensure completion and proper operation. Verification of alarm connection to an alarm company shall be submitted in writing by a representative of the alarm company to the Fire Marshal. Alarm companies under this section will meet current N.F.P.A. 72 Standards.

Suitable signs must be provided on the door of the enclosure that contains any sprinkler system valves and/or controls. The signs shall state "Fire Sprinkler Control Valves" in two (2) inch high block letters with a minimum stroke of one half (½) inch, and of a color contrasting with its background. Valves or switches that are located within building elements must also be identified in an approved, suitable, and easily identifiable manner at the point of access to said valve or component.

All fire department connections shall be installed at a location approved by the College Station Fire Marshal's Office. Fire department connections shall be immediately discernible. A minimum of five (5) feet of clear space shall be maintained around any fire department connection or fire department control valve.

A fire hydrant capable of supplying the sprinkler system shall be located a maximum of one hundred (100) feet from the fire department connection.

Shelving units and shelves shall be constructed so that storage will be no closer than two (2) feet below any ceiling or closer than eighteen (18) inches below the horizontal plane of any sprinkler head deflector.

A U.L. approved outside electric or hydraulic warning device (bell or horn) shall be installed on the outside of the structure proximate to the fire department connection of a building protected by a sprinkler system.

Sprinkler valves shall be secured in accordance with N.F.P.A. 13. In sprinkler-protected structures that are protected with a fire alarm detection system, valves shall be tied directly into a supervisory alarm circuit and shall be monitored through the fire alarm system. In structures that are not protected by a fire alarm system, the sprinkler control valves shall be secured by one of the following methods: Locked in the open position with a chain and/or padlock; locked in a room designated for that purpose and identified on the door accordingly; or locked in a cage or other approved area that can be adequately supervised and secured.

Kitchen Fire Extinguishing Systems

Cooking hood-extinguishing systems providing protection for cooking and ventilation equipment will be reviewed by the Fire Marshal's Office. For a complete review to take place the following information shall be provided:

1. A full set of drawings shall be submitted through eTRAKiT to the College Station Fire Marshal's office.
2. Description of extinguishing system type (automatic sprinkler, carbon dioxide or liquid agent).

3. Type of system design (Engineered system versus a pre-engineered system).
4. Engineered and pre-engineered systems shall contain full details of system design.
5. Design shall specifically note interconnection for fuel supply shutoff, ventilation control, damper control, associated ducting system, etc. Power to appliances (gas, electrical, etc.) located under the protection of the extinguishing system shall completely shut off upon system activation.
6. Cooking hood extinguishing systems shall be designed in accordance with the latest locally adopted editions of N.F.P.A. 12, 12A, 13, 17,17A, and 96; the International Fire Code, International Building Code, International Mechanical Code, and any applicable local amendments and rules.
7. Monitoring of cooking hood suppression systems shall be in accordance with N.F.P.A. 72 when applicable.
8. An inert gas blow-off test shall be conducted on all new or remodeled systems prior to acceptance. The permit fee shall be paid at the College Station Building Department. If the system does not pass it is left to the discretion of the inspector as to whether an additional test fee is required.
9. Please allow twenty-four (24) hours advance notice for a system test. Call the College Station Fire Marshal Office to schedule an acceptance test.

Appendix A

FIRE HYDRANT INSTALLATION DETAIL

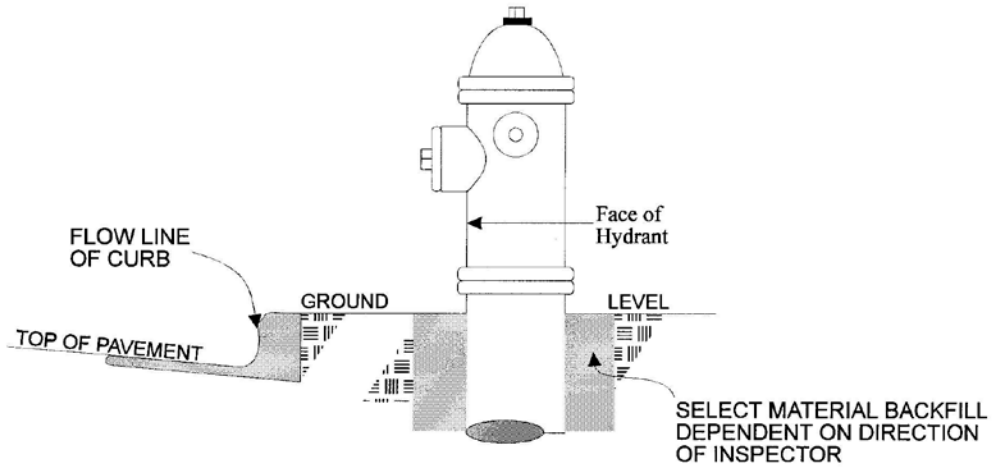

GENERAL NOTES

- 1) HYDRANT NOZZLES SHALL BE POSITIONED AT RIGHT ANGLES TO CURB. IF NO CURB OR SIDEWALK EXISTS, CONTACT FIRE MARSHALL'S OFFICE FOR SITE EVALUATION
- 2) HYDRANTS WILL BE PLACED A MINIMUM OF 5.0 FT. FROM ANY UTILITY OR DRAINAGE STRUCTURE

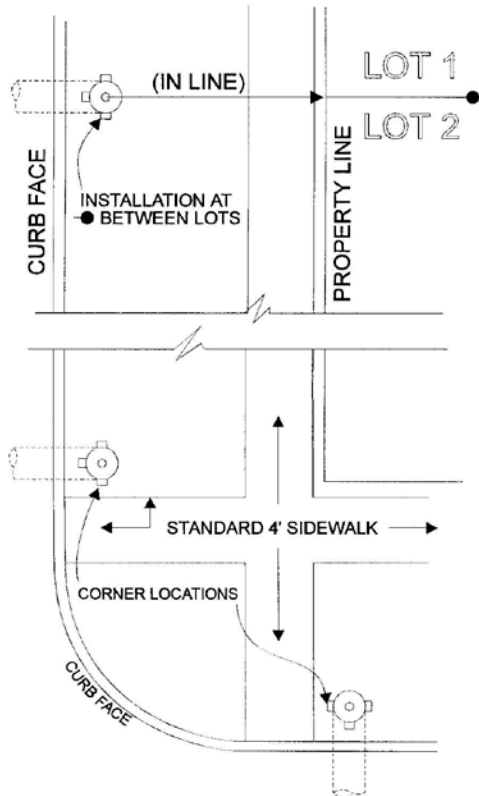

DETACHED SIDEWALK LOCATIONS

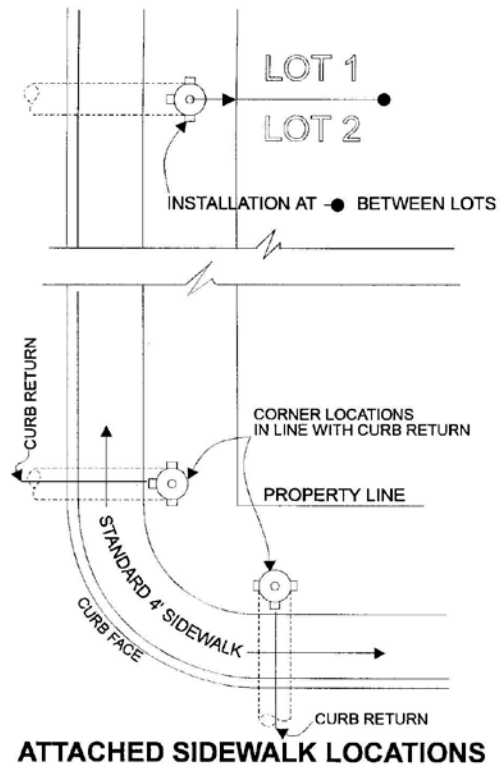

ATTACHED SIDEWALK LOCATIONS

FIRE HYDRANT BOLLARD DETAIL

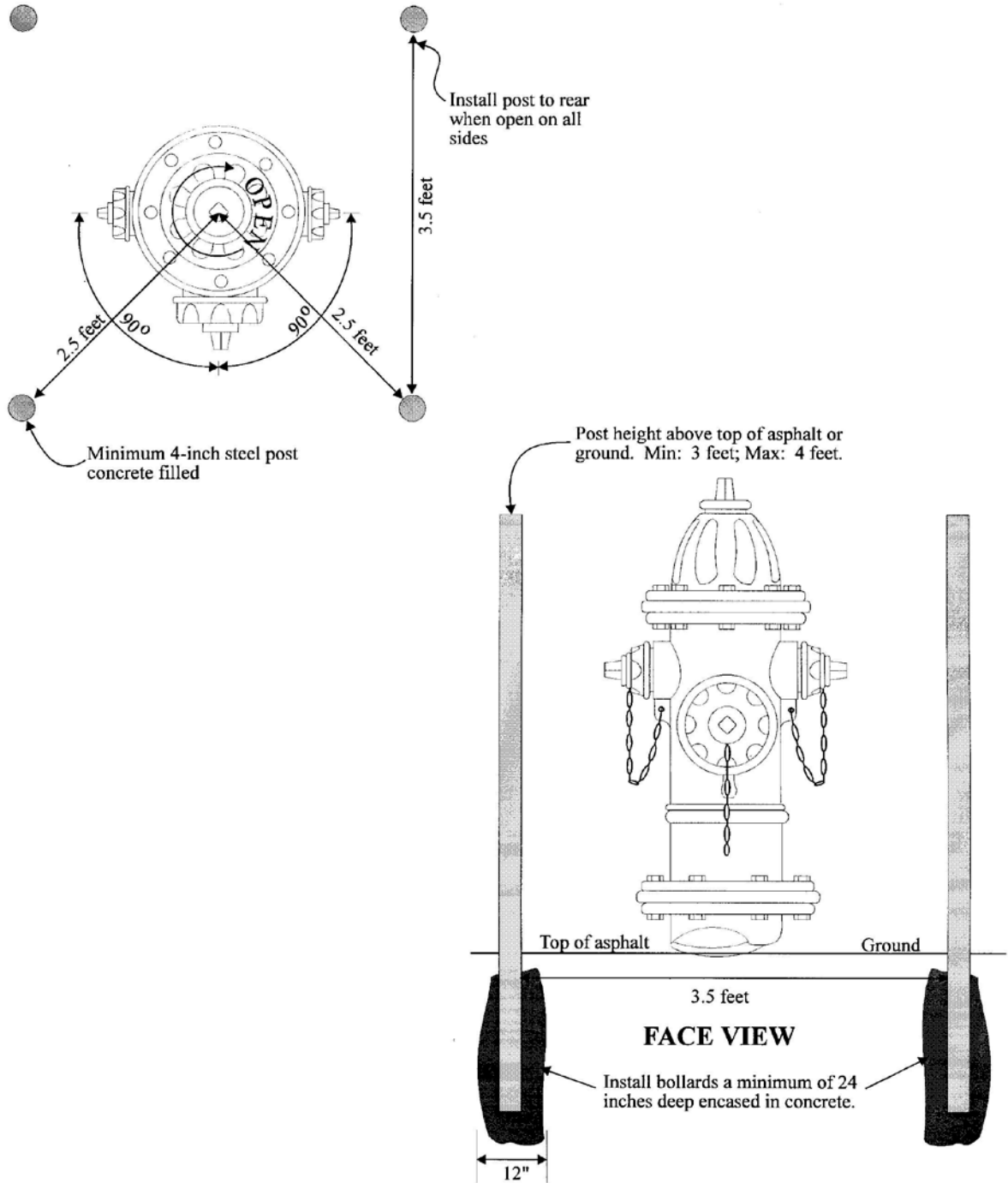

A2



APPROVED ACCESS ROADWAY TURNAROUNDS

City Access Roadways

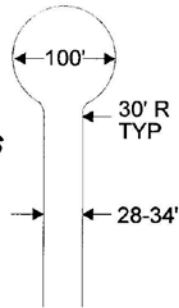

Cul-de-sac not to exceed 600 feet

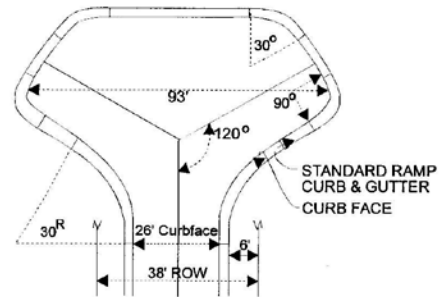

Alternate access roadways considerations for private driveways (one to two homes maximum) and special approved applications.

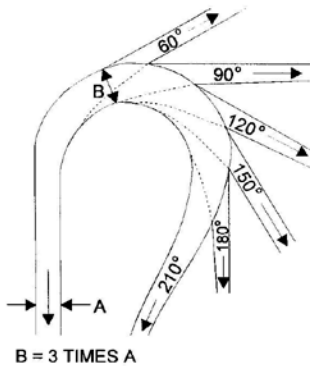
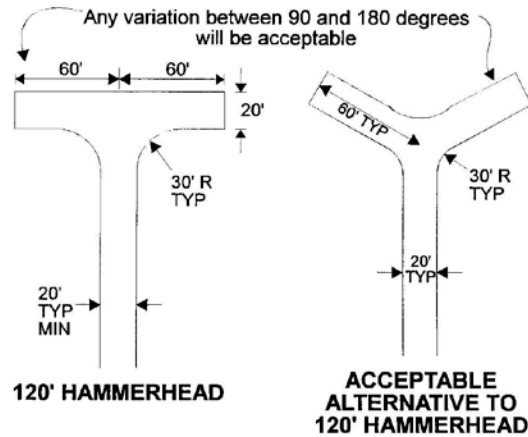
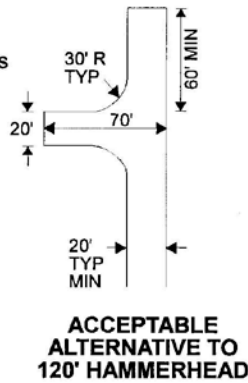

**SEMITRAILER WHEELTRACKS
48' RADIUS**

Misc.

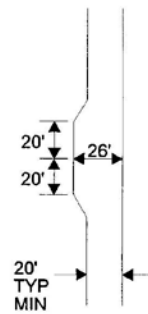

**MINIMUM CLEARANCE
AROUND A FIRE HYDRANT**

TURNING RADIUS SPECIFICATIONS

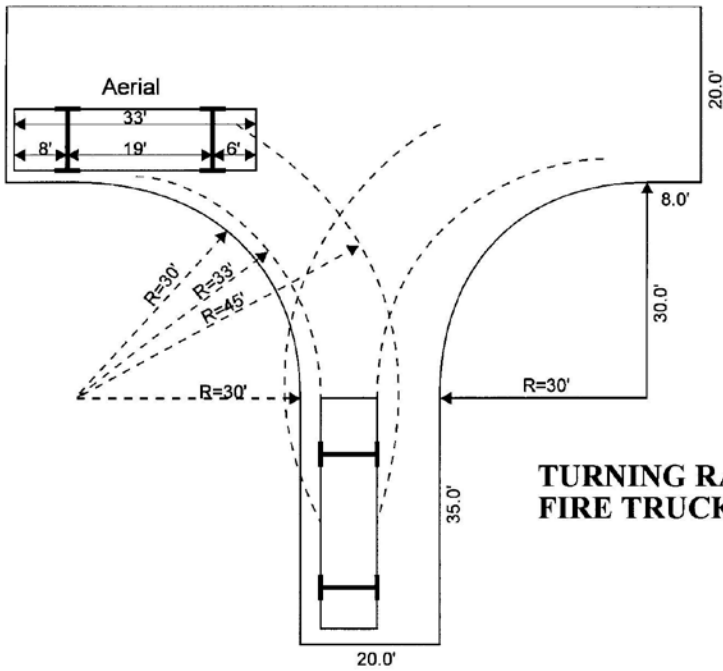

TURNING RADIUS REQUIRED FOR FIRE TRUCKS IN A TEE TURNAROUND

TURNING RADIUS REQUIRED FOR FIRE TRUCKS IN A CIRCLE TURNAROUND

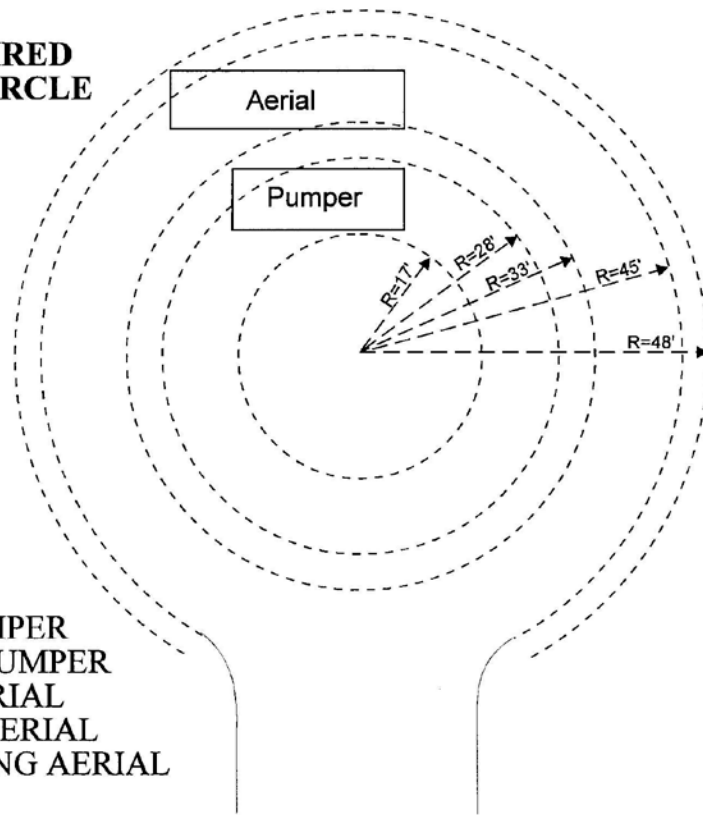

- R-17': INSIDE WHEEL PUMPER
- R=28': OUTSIDE WHEEL PUMPER
- R=33': INSIDE WHEEL AERIAL
- R=45': OUTSIDE WHEEL AERIAL
- R=48': OUTSIDE OVERHANG AERIAL

FIRE LANE MARKINGS

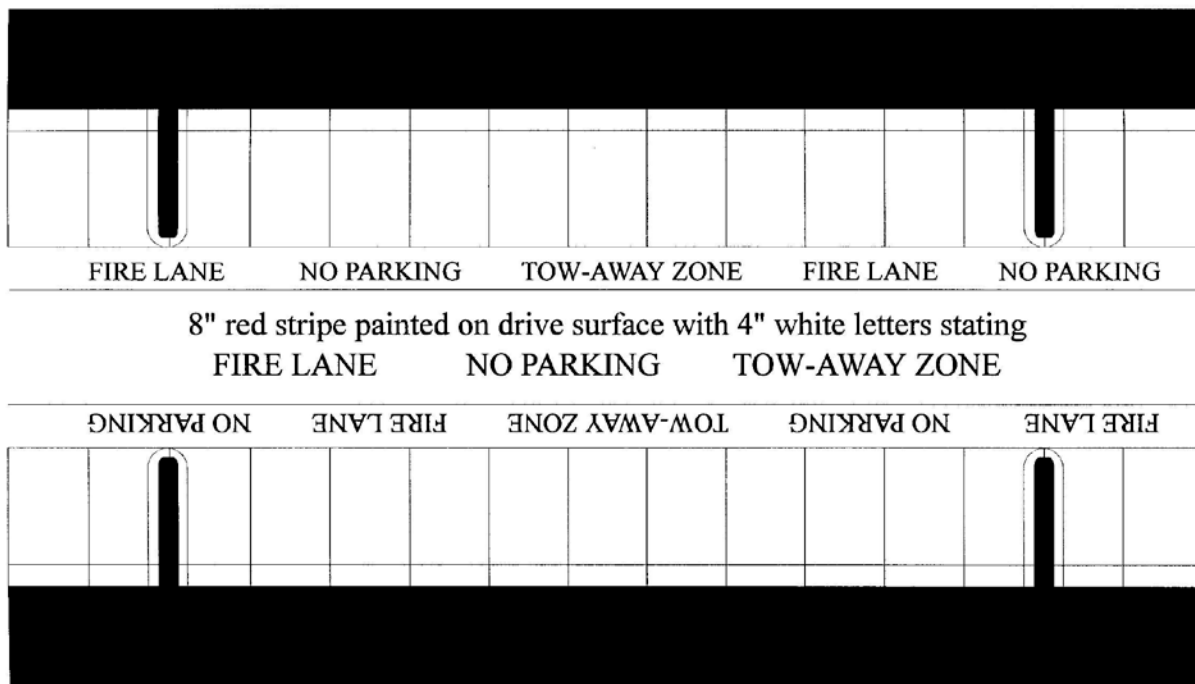

Ordinance No. 2529
Chapter 6 Section 1 (B) (14)
Subsection 503.3
City of College Station
Code of Ordinances

503.3 Fire Lane Markings

- (a) The owner, manager, or person in charge of any building or property to which fire lanes have been approved or required by engineering shall mark and maintain said fire lanes in the following manner:

All curbs and curb ends shall be painted red with four (4) inch white lettering stating "FIRE LANE -NO PARKING -TOW AWAY ZONE". Wording may not be spaced more than fifteen (15) feet apart.

In areas where fire lanes are required, but no continuous curb is available, one of the following methods shall be used, in conjunction with the curb markings, to indicate that the fire lane is continuous:

- Option # 1: A sign twelve (12) inches wide and eighteen (18) inches in height shall be mounted in a conspicuous location at each entrance to the property. Signs shall be mounted no closer than four (4) feet or higher than five (5) feet above grade level as measured from the top of the sign. (See appendix A-5 for sign specifications)
- Option # 2: From the point the fire lane begins to the point the fire lane ends, including behind all parking spaces which adjoin a fire lane, shall be marked with one continuous eight (8) inch red stripe painted on the drive surface behind the parking spaces. All curbing adjoining a fire lane must be painted red. Red stripes and curbs will contain the wording "FIRE LANE-NO PARKING-TOW AWAY ZONE" painted in four (4) inch white letters. (See appendix A-5 for more information)

Exit Sign Requirements

- Exit signs shall be installed and comply with the 2015 International Building Code requirements.
- Additional exit signs, lights, or markings may be required to assure the exit way is readily identifiable regardless of the occupant load.
- Graphics on exit signs shall be BLOCK letters a minimum of six (6) inches in height with a minimum stroke of three-quarter ($\frac{3}{4}$) inches.
- A secondary or emergency source of illumination shall be provided for all occupancies. Duration of the emergency power shall be no less than one and one half ($1\frac{1}{2}$) hours.
- Required illuminated signs shall be internally or externally illuminated in accordance with 2015 International Fire Code section 1008.
- Exit signs shall be installed at all required exit doorways and where otherwise necessary to clearly indicate the available egress systems. If two (2) or more exits are required, exit of the respective exit ways must be indicated with signs to clearly indicate each individual exit egress system.

Appendix B

College Station Fire Department Standard Comments

1. Prior to and during all phases of combustible construction all required access roadways and fire lanes must be made serviceable and maintained for fire protection and emergency medical purposes.
2. Required street and "on-site" fire hydrants and water mains must be installed, operable (wet) and accepted by the Engineering Division. Compliance with applicable sections of the 2015 International Fire Code, 2015 International Building Code and City Ordinances is required.
3. Access roadways shall extend to within one hundred fifty (150) feet of all first story exterior portions of any building in accordance with 2015 International Fire Code Section 503.1.1.
4. Fire Department access roadways shall be a minimum of twenty (20) feet wide; have a minimum of fourteen (14) feet of vertical clearance; be maintained and unobstructed in all types of weather; be engineered and constructed to support the weight of a fire apparatus in accordance with Chapter 6 Section 1 (B) (12) City of College Station Code of Ordinances. Any eaves or top of parapet walls of buildings or facilities exceeding 30 feet in height above the lowest level of fire department vehicle access shall be provided with approved fire apparatus access roads capable of accommodating fire department aerial apparatus. Overhead utility and power lines shall not be located within the aerial fire apparatus access road. Fire apparatus access road shall have a minimum unobstructed width of 26 feet in the immediate vicinity of any building or portion of building requiring an aerial access. At least one of the required access routes meeting this condition shall be located within a minimum of 15 feet and a maximum of 30 feet from the building, and shall be positioned parallel to one entire side of the building.
5. Dead-end access roads (with required fire lanes) in excess of one hundred (100) feet in length shall be provided with an approved fire department turnaround in accordance with Chapter 6 section 1 (B) (13) City of College Station Code of Ordinances. (See appendix A-3 for approved turnarounds)
6. Cul-de-sacs shall not exceed twelve hundred (1200) feet in length in the city and two thousand (2000) rural to radius point, and shall terminate in a turnaround not less than one hundred (100) feet in diameter, with a pavement diameter of eighty (80) feet.
7. Fire lanes shall be established and marked as per Chapter 6 Section 1 (B) (14/15) subsections 503.2., 503.2.1, 503.2.2, and 503.2.3 City of College Station Code of Ordinances.

College Station Fire Department Requirements for Plans Submittal

New Commercial Buildings

Plans are to be submitted through eTRAKiT and shall include but is not limited to:

- ' Site plan (including all parking, driving surfaces and adjacent Public Street)
- ' Floor plan
- ' Mechanical Details
- ' Electrical Details (exit lighting, emergency lighting, etc.)
- ' Approved Site Construction Documents (i.e., water lines for fire hydrants, fire hydrant[s])
- ' Proposed use
- ' Plans shall indicate floor level (1st, 2nd, etc.).
- ' A legend is required for clarification.
- ' Registered Architect or Engineer's seal will be placed on plans when required (outlines provided in the International Building Code).
- ' Title box with the following information:
 1. Name of architectural or engineering firm.
 2. Address of same.
 3. Phone number.
 4. Site address.
- ' If the new structure requires the installation of a fire sprinkler system (required by either the 2015 International Building Code, 2015 International Fire Code or City Ordinance) fire sprinkler plans must be submitted and meet the standards of N.F.P.A. 13.
- ' Locations of all cooking facilities (fire suppression systems, hood systems, etc.)
- ' Buildings protected by a fire sprinkler system(s) shall be monitored by a licensed alarm company at all times and provide written verification of same.

College Station Fire Department Requirement for Plans Submittal

Commercial Tenant Lease Space -- New or Remodeled

Plans are to be submitted through eTRAKiT and shall include but is not limited to:

- ' Site plan of building and affected area of construction
- ' Floor plan
- ' Proposed use
- ' Scale used (architectural or engineering only).
- ' Plans shall indicate floor level (1st, 2nd, etc.).
- ' A legend is required for clarification.
- ' North directional arrow
- ' Title box with the following information:
 1. Name of contractor, architectural or engineering firm.
 2. Address of the same.
 3. Phone number.
 4. Site address.
- ' If structure has an existing fire sprinkler system or is required to install a new system, the fire sprinkler plans must be submitted and meet the standards of N.F.P.A. 13.
- ' Locations of all cooking facilities (fire suppression systems, hood systems, etc.)
- ' If footprint or outside dimension of the building is changed the additional information below is required:
 1. Fire hydrant locations.
 2. Parking and drive surfaces located around the building.
 3. All adjacent public streets.

College Station Fire Department Addressing Requirements City Of College Station Code of Ordinances

505.1 Specifications for Numbers

An official building number placed pursuant to this ordinance must be at least four inches (4") high, and have at least a one-half inch (1/2") stroke in the main body of the number, and be composed of a durable material and of a color which provides a contrast to the background. The number shall be mounted a minimum of thirty-six inches (36") and a maximum of thirty feet (30') in height measured from ground level. Buildings located more than fifty feet (50') from the curb of a street shall have numbers at least five inches (5") in height. For the purpose of this ordinance, durable materials for use in numbering shall include but not be limited to wood, plastic, metal, weather-resistant paint, weather-resistant vinyl, or weather-resistant numbers designed for outside use on a glass surface. For single family residences, the requirement of this section may be met by providing two inch (2") high numbers on both sides of a U.S. mailbox located near the curb in front of the house, or a freestanding structure with numbers at least four inches (4") in height.

505.1.1.4 Numbering Within Building Complexes; Numbering Rear Accesses

A building complex composed of multiple structures shall have an official number assigned to each building as well as a street number. Each unit within each building must also be assigned an official number. If there is sufficient street frontage, each unit within each building must also be assigned an official number. If there is sufficient street frontage, each unit or building may be assigned a separate official street address number. The official number of each structure must be prominently posted on the building so that it is visible from the nearest public street. Each number designated by the Building Official must be prominently posted on the building so that it is visible from the nearest public street. Each number designated by the Building Official for each individual unit must be conspicuously posted on the unit.

Commercial buildings shall also display the business name and designated address on each outside door.

Residential structures, which provide for rear vehicular access from a dedicated public alley, shall conspicuously post the designated number so that it is visible to the alley.

The owner of a building complex which contains an enclosed shopping mall shall submit to the Fire Official four (4) copies of diagrams acceptable to the Fire Official of the entire complex, indicating the location and number of each business. When a change in a business name or location is made, the owner or manager of structure shall so advise the Fire Official in writing of the change.

Attachment I
Clean Agent Fire Extinguishing
System Acceptance Form

**Clean Agent Fire Extinguishing System
Acceptance Checklist**



Building #: _____ **Building Name:** _____ **Date:** _____

Attendees: _____

Clean Agent System Manufacturer: _____

Control Panel Manufacturer: _____

Room or Area Protected: _____

Type of Extinguishing Agent: _____

Volume Protected Above Ceiling Below Raised Floor Between Floor and Ceiling

System Concentration (%) _____

Weight of Clean Agent With Cylinder _____ **lbs.**

Weight of Cylinder _____ **lbs.**

Weight of Clean Agent _____ **lbs.**

Normal Operating Pressure _____ **psi**

Detection System:

- Ionization-type smoke detectors
- Photoelectric smoke detectors
- Rate-of-rise heat detectors
- Fixed-temperature heat detectors
- Rate-compensation heat detectors
- Other _____

Type of Detection for Operation:

- Single Zone
- Two Zones (cross zoned)
- Two detectors any zone
- Other _____

Requirements Before Acceptance Testing:

- Building construction is complete
- All trades are complete
- Clean-up is complete
- Fire Protection and life safety system integrated with fire alarm system complete and pre-tested
- All devices verified with correct address/location shown on as built drawings

Required Documentation at Time of Acceptance Test:

- FML-009- 1 Copy to EHS Yes No
- O&M Manual transferred to AM Personnel Yes No
- Transfer of any special tools To AM Personnel Yes No
- Sensitivity of smoke detectors received by EHS Yes No

Acceptance Test

Clean Agent Containers Free From Physical Damage	<input type="checkbox"/> Yes	<input type="checkbox"/> No
Warning Signage Installed at Doorways with Relevant Instruction/Information	<input type="checkbox"/> Yes	<input type="checkbox"/> No
Visible Warning Device (Strobe) Outside of Room	<input type="checkbox"/> Yes	<input type="checkbox"/> No
Warning and Instruction Signs Posted Outside Cylinder Storage Room	<input type="checkbox"/> Yes	<input type="checkbox"/> No
Main and Reserve (if Present) Tanks Clearly Identified	<input type="checkbox"/> Yes	<input type="checkbox"/> No
Warning Sign Affixed by Manual Pull	<input type="checkbox"/> Yes	<input type="checkbox"/> No
Piping, Joints, Discharge Nozzles Secure	<input type="checkbox"/> Yes	<input type="checkbox"/> No
Information Tag Attached (Agent, Tare, Gross Weight)	<input type="checkbox"/> Yes	<input type="checkbox"/> No
Verify Storage Containers are Secured	<input type="checkbox"/> Yes	<input type="checkbox"/> No
Pneumatic Test on Piping (10 min @ 40 psi)	<input type="checkbox"/> Yes	<input type="checkbox"/> No
Enclosure Integrity Test - Change of 10 Pa (.15psi) or less	<input type="checkbox"/> Yes	<input type="checkbox"/> No
Flow Test (Puff Test)	<input type="checkbox"/> Yes	<input type="checkbox"/> No
Batteries Shall Power Full Alarm For 15 Minutes	<input type="checkbox"/> Yes	<input type="checkbox"/> No
Properly Labeled Dedicated Power Circuit	<input type="checkbox"/> Yes	<input type="checkbox"/> No
Functional Test of Detectors	<input type="checkbox"/> Yes	<input type="checkbox"/> No
Functional Test of All Manual Pull Stations (2 Separate and Distinct Functions) Push & Pull	<input type="checkbox"/> Yes	<input type="checkbox"/> No
Functional Test of Abort Switches	<input type="checkbox"/> Yes	<input type="checkbox"/> No
Functional Test of All Audio/Visual Devices	<input type="checkbox"/> Yes	<input type="checkbox"/> No
Functional Test of Control Panel	<input type="checkbox"/> Yes	<input type="checkbox"/> No
Functional Test of All Remote Annunciators	<input type="checkbox"/> Yes	<input type="checkbox"/> No
Verification of Trouble Alarms: <input type="checkbox"/> Battery Charger <input type="checkbox"/> Loss of Bottle Pressure (Pressure Shall be Supervised) <input type="checkbox"/> Smoke <input type="checkbox"/> A/V <input type="checkbox"/> Loss of Dedicated Power	<input type="checkbox"/> Yes	<input type="checkbox"/> No
Verification of Supervisory Alarms	<input type="checkbox"/> Yes	<input type="checkbox"/> No
Functional Test of All Relays: <input type="checkbox"/> AHU Shutdown & Damper Closure <input type="checkbox"/> Other	<input type="checkbox"/> Yes	<input type="checkbox"/> No
Test System on Backup Power by Simulating Primary Power Failure	<input type="checkbox"/> Yes	<input type="checkbox"/> No
Verify Alarm, Supervisory, and Trouble Signals Received at Communication Center	<input type="checkbox"/> Yes	<input type="checkbox"/> No
Verify Dedicated Power Source	<input type="checkbox"/> Yes	<input type="checkbox"/> No
Verify 24 Hour Standby Power Source	<input type="checkbox"/> Yes	<input type="checkbox"/> No
O&M Manual Transferred to AM Personnel	<input type="checkbox"/> Yes	<input type="checkbox"/> No
Transfer of Any Special Tools To AM Personnel	<input type="checkbox"/> Yes	<input type="checkbox"/> No
Other:	<input type="checkbox"/> Yes	<input type="checkbox"/> No

Code References:

- If abort switch is used, abort switch shall only be valid after 1st detector reports. After 2nd detector reports, abort switch shall no longer be functional. (Only valid in zoned 2 detection systems).
- 30 Seconds max for time delay release.
- If dead man switch is pressed and no alarm condition is present, a trouble signal shall be indicated.
- Manual discharge shall bypass time delay and dead man switch
- If smoke detector is in trouble, system shall still operate
- Operation of abort switch shall result in both audible and distinct visual indication of system impairment. NFPA 2001 -4.3.5.4
- The piping shall be pneumatically tested in a closed circuit for a period of 10 minutes at 40psi. At the end of 10 minutes, the pressure drop shall not exceed 20 percent of the test pressure. 7.7.2.2.12

Comments:

Attachment II
Elevator Acceptance Checklist

Elevator Acceptance Checklist



Building #: _____ **Building Name:** _____ **Date:** _____

Attendees: _____

Project Number: _____ **Type of Elevator:** Traction Hydraulic

Elevator Location: _____

Requirements Before Acceptance Testing:

Elevator has been pretested Yes No

Elevator Has Identifier (1, 2, A, B, etc.)	<input type="checkbox"/> Yes	<input type="checkbox"/> No	
Elevator Shaft Sprinkled	<input type="checkbox"/> Yes	<input type="checkbox"/> No	<input type="checkbox"/> N/A
Elevator Machine Room Sprinkled	<input type="checkbox"/> Yes	<input type="checkbox"/> No	<input type="checkbox"/> N/A
Sprinkler Head no More Than 2 ft. From Pit Floor	<input type="checkbox"/> Yes	<input type="checkbox"/> No	<input type="checkbox"/> N/A
If Sprinkled, Heat & Smoke Detection Required (Heat w/in 24" of Sprinkler)	<input type="checkbox"/> Yes	<input type="checkbox"/> No	<input type="checkbox"/> N/A
If Sprinkled, Shunt Trip Present and Operational	<input type="checkbox"/> Yes	<input type="checkbox"/> No	<input type="checkbox"/> N/A
Hoistway Smoke Relief Dampers Present <input type="checkbox"/> Verify Normally Closed and Will Open in Alarm	<input type="checkbox"/> Yes	<input type="checkbox"/> No	
Fire Hat Lights Up in Alarm Mode	<input type="checkbox"/> Yes	<input type="checkbox"/> No	
Fire Hat Flashes with Activation of Machine Room/Shaft Detection	<input type="checkbox"/> Yes	<input type="checkbox"/> No	
Emergency Call Operational and Location Accurate	<input type="checkbox"/> Yes	<input type="checkbox"/> No	
Emergency Call-Back Operational	<input type="checkbox"/> Yes	<input type="checkbox"/> No	
Primary Recall Reports to Correct Location	<input type="checkbox"/> Yes	<input type="checkbox"/> No	
Secondary Recall Reports to Correct Location	<input type="checkbox"/> Yes	<input type="checkbox"/> No	
Smoke Detection Tested at All Levels <input type="checkbox"/> Smoke Detectors Located on Ceiling Within 21' of Center-line of Doors	<input type="checkbox"/> Yes	<input type="checkbox"/> No	
Phase II (Fire Operation) Operating Correctly	<input type="checkbox"/> Yes	<input type="checkbox"/> No	<input type="checkbox"/> N/A
Other: _____	<input type="checkbox"/> Yes	<input type="checkbox"/> No	<input type="checkbox"/> N/A

Notes: Smoke detectors shall not be installed in un-sprinkled hoistways unless they are installed to activate elevator hoistway smoke relief equipment or to initiate Phase I Emergency Recall Operations (NFPA 72:21.3.6, 2016)

Applicable Codes/Standards: NFPA 1, NFPA 101, ASME A17.1

Elevator Accepted by TAMU EHS Yes No

Comments:

**Attachment III
Emergency Power Supply Systems
Acceptance Checklist**

Emergency Power Supply Systems Acceptance Checklist



Building #: _____ **Building Name:** _____ **Date:** _____

Attendees: _____

Project Number : _____

NOTE: All trades complete, system has been pre-tested for emergency power transfer, all circuits identified as emergency circuits are functional

Generator Location: _____

Generator Level/Class: _____ **Generator Type:** _____

Generator Manufacturer: _____

Prime Mover Manufacturer: _____

KVA (or KW) _____ **@** _____ **Hz** **Rated RPM** _____ **@ 100%**

Transfer Switches _____ **Energy Source** _____

Remote Annunciator Location(s): _____

Type of Diesel Fuel Tank:

- Aboveground
- Underground
- Fire resistant aboveground
- Underground vault
- Secondary containment aboveground tank
 - Indoors
 - Outdoors
- Other specialty tank (Specify) _____

Location(s) of diesel fuel storage tanks:

- In building, floor _____ Quantity (gallons) _____
- Outdoors, Location _____ Quantity (gallons) _____

The Following Documents Shall Be Provided To The AHJ At The Time Of The Acceptance Test:

- Evidence of the prototype test as specified in NFPA 110 5.2.1.2 (for level 1 systems)
- A certified analysis as specified in NFPA 110 5.6.10.2
- A Letter of Compliance as specified in NFPA 110 5.6.10.5
- A manufacturer's certification of a rated load test at rated power factor with the ambient temperature, altitude, and fuel grade recorded
- Schematic, wiring, and interconnection diagrams showing all terminal and destination markings for all EPS equipment, as well as the functional relationship between all electrical components. NFPA 110, 5.6.10.4
- For Level 1 systems, instruction manuals shall be kept in a secure, convenient location, one set near the equipment, and the other set in a separate location.

General:

- The room shall have a minimum 2-hour fire rating or be located in an adequate enclosure located outside the building capable of resisting the entrance of snow or rain at a maximum wind velocity required by local building codes. NFPA 110, 7.2.1.1.

- ❑ Pilot lights w/ ID nameplates or other approved indicators showing transfer switch position.
- ❑ Mounting platform At Least 6" above floor or grade level.
- ❑ Generator controllers monitored by fire alarm system or attended location for the following items:
 1. Generator Running
 2. Generator fault
 3. Generator switch in non-automatic position
- ❑ Battery charger furnished with the following properly marked:
 1. Allowable range of battery unit capacity
 2. Nominal output current and voltage
 3. Sufficient battery-type data to allow replacement batteries to be obtained
- ❑ Remote manual shutdown station provided.
- ❑ EPS shall have minimum clearance of 3' on all sides.
- ❑ Battery powered emergency lighting shall be provided.
- ❑ Ambient temperature above 40F.

Fuel System Tanks:

- ❑ A minimum clearance of 36" shall be maintained on all sides. NFPA 110 7.9.12.1

For Further Fuel System Requirements, See NFPA 110, 5.5 & 7.9

Exhaust Systems:

See NFPA 110, 7.10 for indoor exhaust requirements.

Acceptance Test: NFPA 110 7.13.4

- ❑ For any generator serving emergency lighting, the load must be picked up by the generator within 10 seconds. NFPA 101, Life Safety Code
- ❑ All paralleled EPSSs intended to be operated simultaneously shall be operated simultaneously
- ❑ Test load shall be loads that are served by the EPSS
- ❑ Observe/ Record time delay on cold start
- ❑ Observe/ Record crank time until prime mover starts and runs
- ❑ Observe/Record time to reach operating speed
- ❑ Confirm Engine start function by verifying operation of the initiating circuit of all transfer switches supplying EPSS loads
- ❑ Observe/ Record time to achieve steady-state condition with all switches transferred to the emergency position
- ❑ Record voltage, frequency, and amperes.
- ❑ Record prime mover oil pressure and water temperature.
- ❑ Continue load test with intended load for not less than 1.5 hours, run time shall be recorded
 - Type U= Basically uninterruptible
 - Type 10= 10 Seconds
 - Type 60= 60 seconds
 - Type 120= 120 seconds

Type M= manual or stationary-no time limit

- Record time for switch over back to normal power. (minimum setting of 5 minutes for each switch)
- Record time delay on the prime mover cool down period and shutdown.
- Prime mover shall be allowed to cool for not less than 5 minutes.

Load Test:

After the above test, conduct 2-hour full load test.

(Building load shall be allowed to serve as part or all of the load, supplemented by load bank of sufficient size to provide a load equal to 100 percent of the nameplate kW rating.)

Load test shall follow the following schedule:

- Not less than 30% of KW in first 30 minutes
- Not less than 50% of KW in the next 30 minutes
- 100% of the nameplate KW for the next 60 minutes

Where EPS is a paralleled multi-unit EPS, each unit shall be permitted to be tested individually at its rating.

Crank Cycle Test:

Any method recommended by the manufacturer for the cycle crank test shall be utilized to prevent the prime mover from running.

Set control switch to “run”

Perform crank/rest cycle (see NFPA 110, 5.6.4.2)

- Crank cycle test shall consist of an automatic crank period of approximately 15 seconds followed by a rest period of approximately 15 seconds.
- *Otto cycle prime movers of 15kW and lower and all diesel prime movers shall be permitted to use continuous cranking methods.
- Crank cycle shall last for approximately 75 seconds(crank, rest, crank, rest, crank)
- Continuous crank test shall last for approximately 45 seconds
- Two means of cranking termination shall be utilized so that one serves as backup to prevent inadvertent starter engagement

Safety/ Alarm Test: (see NFPA 110, 5.6.5)

It shall be acceptable for the manufacturer to test and document over crank, high engine temperature, low lube oil pressure and over speed safeties prior to shipment.

If not tested at manufacturer, above safeties must be tested on site.

LEVEL 1

Indicator Function (at battery Voltage)	CV	S	RA	Item Checked/ Tested By Contractor	Witnessed by FP&C or TAMU EHS
(a)Over Crank	X	X	X		
(b)Low Water Temperature	X	NA	X		
(c)High Engine Temperature Pre-alarm	X	NA	X		
(d)High Engine Temperature	X	X	X		
(e)Low Lube Oil Pressure	X	X	X		
(f)Over Speed	X	X	X		
(g)Low Fuel Main Tank	X	NA	X		
(h)Low Coolant Level	X	O	X		
(i)EPS Supplying Load	X	NA	NA		
(j)Control Switch Not in Automatic Position	X	NA	X		

(k)High Battery Voltage	X	NA	NA		
(l)Low Cranking Voltage	X	NA	X		
(m)Low Voltage in Battery	X	NA	NA		
(n)Battery Charger AC Failure	X	NA	NA		
(o)Lamp Test	X	NA	NA		
(p>Contact for Local and Remote Common Alarm	X	NA	X		
(q)Audible Alarm Silencing Switch	NA	NA	X		
(r)Low Starting Air Pressure	X	NA	NA		
(s)Low Starting Hydraulic pressure	X	NA	NA		
(t)Air Shutdown Damper	X	X	X		
(u)Remote Emergency Stop	NA	X	NA		

CV: Control panel-mounted visual. S: Shutdown of EPS indication. RA: Remote audible. X: Required.
O: Optional. NA: Not applicable.

NOTES:

- (1) Item “p” shall be provided, but a separate remote audible signal shall not be required when the regular work site in NFPA 110, 5.6.6 is staffed 24 hours a day
- (2) Item “b” is not required for combustion turbines
- (3) Item “r” or “s” shall not apply only where used as a starting method
- (4) Item “I” EPS ac ammeter shall be permitted for this function
- (5) All required CV functions shall be visually annunciated by a remote, common visual indicator
- (6) All required functions indicated in the RA column shall be annunciated by a remote, common audible alarm as required in NFPA 110, 5.6.5.3(4)
- (7) Item “g” on gaseous systems shall require a low gas pressure alarm
- (8) Item “b” shall be set at 20F below the regulated temperature determined by the EPS manufacturer as required in 5.3.1

<u>Testing Time Requirements</u>			
Class:	Max. Time	Type:	Power Restoration Minimums
0.083	5 min	U	Basically uninterrupted
0.25	15 min	10	10 sec (NFPA 101)
2	2 hr.	60	60 sec
6	2 hr.	120	120 sec
48	2 hr.	M	Manual or non-automatic
X	2 hr.		(no time limit)

See also NFPA 110, 4.1

APPENDIX A:

- (1) Certification provided verifying the torsional vibration compatibility of the rotating element of the prime mover and the generator for the intended use of the energy converter. NFPA 110, 5.6.10.2
- (2) The Energy converter supplier shall stipulate compliance and performance with this standard for the entire unit when installed. NFPA 110, 5.6.10.5
- (3) 8.2.2 For Level 1 systems, instruction manuals shall be kept in a secure, convenient location, one set near the equipment, and the other set in a separate location.
- (4) Two pilot lights with identification nameplates or other approved position indicators shall be provided to indicate the transfer switch position. NFPA 110, 6.2.13
- (5) Mounting locations shall raise the engine at least 6” above the floor or grade level and be of sufficient elevation to facilitate lubricating-oil drainage and ease of maintenance. NFPA 110, 7.4.1.1
- (6) New generator controllers must be monitored by the fire alarm system or at an attended location for the following conditions: NFPA 101, 9.1.3.2
 1. Generator running
 2. Generator fault
 3. Generator switch in non-automatic position

Attachment IV
Emergency Lighting Checklist

Emergency Lighting Checklist



Building #: _____ **Building Name:** _____ **Date:** _____

Attendees: _____

Project Number: _____

Emergency Lighting Provided by:

- Generator
- Battery back-up

Generator Information

Generator Location: _____

Type of Generator, if applicable:

- Emergency power (life safety)
- Stand-by power
- Emergency and stand-by combination

Generator Fuel Source: _____

Generator Fuel Capacity: _____

Fuel Tank Equipped with Secondary Containment: Yes No

Transfer Time (Emergency Generators Only): <= 10 Seconds > 10 Seconds

Emergency Lighting Information:

Adequate lighting provide for egress (1 foot candle at floor level, 10 foot candle for stairways): Yes No

Emergency Lighting Provided at the Following Locations:

Restrooms	<input type="checkbox"/> Yes	<input type="checkbox"/> No	<input type="checkbox"/> N/A
Electrical/Mechanical Rooms	<input type="checkbox"/> Yes	<input type="checkbox"/> No	<input type="checkbox"/> N/A
IT Rooms	<input type="checkbox"/> Yes	<input type="checkbox"/> No	<input type="checkbox"/> N/A
Building Exterior at Egress Doors	<input type="checkbox"/> Yes	<input type="checkbox"/> No	<input type="checkbox"/> N/A
Corridors	<input type="checkbox"/> Yes	<input type="checkbox"/> No	<input type="checkbox"/> N/A
Stairways	<input type="checkbox"/> Yes	<input type="checkbox"/> No	<input type="checkbox"/> N/A
Pump rooms	<input type="checkbox"/> Yes	<input type="checkbox"/> No	<input type="checkbox"/> N/A
Elevator Machine Rooms	<input type="checkbox"/> Yes	<input type="checkbox"/> No	<input type="checkbox"/> N/A
Other:	<input type="checkbox"/> Yes	<input type="checkbox"/> No	<input type="checkbox"/> N/A

Adequate exit signage provided/proper directional chevrons: Yes No

Emergency lighting/exit signage maintained for 90 minutes (battery units only): Yes No

Code Reference: NFPA 1, NFPA 101, NFPA 110

System Accepted by EHS: Yes No

Attachment V
Fire Alarm Certificate of Installation
SFM-TDI Form FML-009



TEXAS DEPARTMENT OF INSURANCE

State Fire Marshal's Office (112-FM)
333 Guadalupe, Austin, Texas 78701 * PO Box 149221, Austin, Texas 78714-9221
(512) 676-6800 | F: (512) 490-1053 | (800) 578-4677 | TDI.love.gov | @TXSRMDO

FIRE ALARM INSTALLATION CERTIFICATE

After completion of an installation, modification, or addition of a system or single station detector (excluding a one or two family residence) the licensee shall complete and present this certificate to the owner or their representative or post the certificate near the main control panel according to the Fire Alarm Rules 28TAC634.617
DISTRIBUTION: Original to owner or posted on site at control panel. Copy 1 to main authority having jurisdiction. Copy 2 Certifying firm to retain in their office for access by SFMO.

Form with fields for Property Name, Bldg. or Floor No., Street, City / Zip, Name of CERTIFYING firm, City / State / Zip, Phone Number, ACR-, and installation details (Code or Std., Year/Edition, Code or Std., Year/Edition).

SYSTEM INFORMATION table with columns: INITIATING DEVICES, NOTIFICATION APPLIANCES, SUPERVISORY DEVICES, and CIRCUIT STYLE/CLASS. Includes rows for Smoke Detectors, Bell, Horn or Chime, Valve Tamper Switches, etc.

RECORD DRAWINGS section with fields for Company, City / State, Planner's Name, License Num., PE or APS, Date on Plan, Revision number/date, and Record Drawings (One with original planner's signature.)

I hereby certify, on behalf of the registered certifying firm, that this fire alarm system has been tested and complies with the requirements of Texas Insurance Code, Chapter 6002, the Fire Alarm Rules, the applicable codes and standards and the manufacturer's installation requirements.

Signature of Licensee: _____ License Number: _____
Printed name of Licensee: _____ Date signed: _____

Attachment VI
Fire Alarm System Acceptance Checklist

Fire Alarm System Acceptance Checklist



Building #: _____ **Building Name:** _____ **Date:** _____

Attendees: _____

Project Number: _____

Fire Alarm Panel Type: _____ **Fire Alarm Panel Location:** _____

Requirements Before Acceptance Testing:

- Building construction is complete; All trades are complete; Clean-up is complete
- Fire Alarm System has been pre-tested
- Fire Protection and life safety system integrated with fire alarm system complete and pre-tested
- All devices verified with correct address/location shown on as built drawings

Required Documentation at Time of Acceptance Test:

- | | |
|---|--|
| <input type="checkbox"/> System as-built plans, all devices, circuitry | <input type="checkbox"/> Yes <input type="checkbox"/> No |
| <input type="checkbox"/> NFPA 72 Record of Completion (NFPA 72, 14.6.2.4) – Copy to EHS | <input type="checkbox"/> Yes <input type="checkbox"/> No |
| <input type="checkbox"/> FML-009 Form Completed– Copy to EHS | <input type="checkbox"/> Yes <input type="checkbox"/> No |
| <input type="checkbox"/> Sensitivity test printout transferred to AM Personnel– Copy to EHS | <input type="checkbox"/> Yes <input type="checkbox"/> No |
| <input type="checkbox"/> O&M Manual transferred to AM Personnel | <input type="checkbox"/> Yes <input type="checkbox"/> No |
| <input type="checkbox"/> Transfer of any special tools to AM Personnel | <input type="checkbox"/> Yes <input type="checkbox"/> No |

Acceptance Test:

FAP Located in Conditioned Space	<input type="checkbox"/> Yes	<input type="checkbox"/> No	<input type="checkbox"/> N/A
Smoke Detector Located Above FAP	<input type="checkbox"/> Yes	<input type="checkbox"/> No	<input type="checkbox"/> N/A
Battery Discharge Test	<input type="checkbox"/> Yes	<input type="checkbox"/> No	
<input type="checkbox"/> 24 Hours (W/O Life Safety Generator)			
<input type="checkbox"/> 4 Hours (With Life Safety Generator)			
Functional Test of All A/V Devices (Horns - 5 Minutes/Voice 15 Minutes)	<input type="checkbox"/> Yes	<input type="checkbox"/> No	<input type="checkbox"/> N/A
All Visual Devices Synchronized	<input type="checkbox"/> Yes	<input type="checkbox"/> No	<input type="checkbox"/> N/A
Activation of Stairway Pressurization System(s)*	<input type="checkbox"/> Yes	<input type="checkbox"/> No	<input type="checkbox"/> N/A
Activation of Smoke Exhaust System(s)**	<input type="checkbox"/> Yes	<input type="checkbox"/> No	<input type="checkbox"/> N/A
Functional Test of All Magnetic Releases	<input type="checkbox"/> Yes	<input type="checkbox"/> No	<input type="checkbox"/> N/A
Proper Activation of Door Hold Open Magnets	<input type="checkbox"/> Yes	<input type="checkbox"/> No	<input type="checkbox"/> N/A
dB Level Check on All Audible Devices (15dB Above Ambient)	<input type="checkbox"/> Yes	<input type="checkbox"/> No	<input type="checkbox"/> N/A
Functional Test of All Flow Switches (30-45 Seconds Preferred)	<input type="checkbox"/> Yes	<input type="checkbox"/> No	<input type="checkbox"/> N/A
Functional Test of All Smoke Detectors	<input type="checkbox"/> Yes	<input type="checkbox"/> No	<input type="checkbox"/> N/A
Functional Test of All Heat Detectors	<input type="checkbox"/> Yes	<input type="checkbox"/> No	<input type="checkbox"/> N/A
Functional Test of All Manual Pull Stations	<input type="checkbox"/> Yes	<input type="checkbox"/> No	<input type="checkbox"/> N/A
Functional Test of All Remote Annunciators	<input type="checkbox"/> Yes	<input type="checkbox"/> No	<input type="checkbox"/> N/A
Functional Test of All Fireman Phones	<input type="checkbox"/> Yes	<input type="checkbox"/> No	<input type="checkbox"/> N/A
Functional Test of All HVAC Duct Detectors	<input type="checkbox"/> Yes	<input type="checkbox"/> No	<input type="checkbox"/> N/A
Record Initial Power Level of Fiber Line (dBm) _____	<input type="checkbox"/> Yes	<input type="checkbox"/> No	<input type="checkbox"/> N/A
Functional Test of All Relays	<input type="checkbox"/> Yes	<input type="checkbox"/> No	<input type="checkbox"/> N/A
<input type="checkbox"/> AHU shutdown			
<input type="checkbox"/> Elevator recall			
<input type="checkbox"/> Suppression systems			
<input type="checkbox"/> Exhaust fans			
<input type="checkbox"/> Pressurization fans			
Verify of Trouble Alarms Reports Within 200 Seconds	<input type="checkbox"/> Yes	<input type="checkbox"/> No	<input type="checkbox"/> N/A
<input type="checkbox"/> Smoke detector circuit			

<input type="checkbox"/> A/V circuit <input type="checkbox"/> Telephone circuit <input type="checkbox"/> Amplifier circuit <input type="checkbox"/> Failure of primary/secondary power supplies <input type="checkbox"/> Initiating device circuit <input type="checkbox"/> Battery charger			
Verify All Supervisory Alarms <input type="checkbox"/> Sprinkler/tamper <input type="checkbox"/> Duct detector	<input type="checkbox"/> Yes	<input type="checkbox"/> No	<input type="checkbox"/> N/A
Verify Alarm, Supervisory, and Trouble Signals Received at the Communications Center - Test all circuits	<input type="checkbox"/> Yes	<input type="checkbox"/> No	<input type="checkbox"/> N/A
Verify All Applicable Faults <input type="checkbox"/> Ground-Fault Monitoring Circuit <input type="checkbox"/> Transmission/receipt of Signal During Open Fault	<input type="checkbox"/> Yes	<input type="checkbox"/> No	<input type="checkbox"/> N/A
Verify FAP Batteries are Sized to Specified Current Draw	<input type="checkbox"/> Yes	<input type="checkbox"/> No	<input type="checkbox"/> N/A
Verify That the Locations of all Power Supplies are Identified at FAP. ("Fire Alarm Circuit")	<input type="checkbox"/> Yes	<input type="checkbox"/> No	<input type="checkbox"/> N/A
Verify Batteries Date of Manufacture - Month/Year	<input type="checkbox"/> Yes	<input type="checkbox"/> No	<input type="checkbox"/> N/A
Verify Breaker Identified/painted Red	<input type="checkbox"/> Yes	<input type="checkbox"/> No	
Verify Installation of Storage Box/As-built Drawings	<input type="checkbox"/> Yes	<input type="checkbox"/> No	<input type="checkbox"/> N/A
Other: _____			

* Use **Stairway Pressurization Acceptance Checklist**

** Use **Smoke Management Acceptance Test Checklist**

Comments:

Attachment VII
Fire Pump Acceptance Checklist

Fire Pump Acceptance Checklist



Building #: _____ **Building Name:** _____ **Date:** _____

Attendees: _____

Project Number: _____

Fire Pump Information

Location of Pump(s): _____

Type of Pump: _____ **Location of Breaker:** _____

Pump Manufacturer: _____ **Pump Fuel Source:** _____

Pump Rated Flow: _____

1 Hour of operation <input type="checkbox"/> Six automatic operations (5 min each) <input type="checkbox"/> Six manual operations (5 min each)	<input type="checkbox"/> Yes	<input type="checkbox"/> No
Flow/pressure test <input type="checkbox"/> No flow <input type="checkbox"/> Rated Flow <input type="checkbox"/> 150% of rated flow	<input type="checkbox"/> Yes	<input type="checkbox"/> No
Functional test of fire pump (pressure drop)	<input type="checkbox"/> Yes	<input type="checkbox"/> No
Functional test of controller	<input type="checkbox"/> Yes	<input type="checkbox"/> No
Load start test	<input type="checkbox"/> Yes	<input type="checkbox"/> No
Phase reversal test <input type="checkbox"/> Normal power supply <input type="checkbox"/> Alternate power supply	<input type="checkbox"/> Yes	<input type="checkbox"/> No
Emergency power operation <input type="checkbox"/> Power Restored in 10 seconds <input type="checkbox"/> Peak Flow Redelivered in 30 seconds	<input type="checkbox"/> Yes	<input type="checkbox"/> No
Verify visible indicators and audible alarm present	<input type="checkbox"/> Yes	<input type="checkbox"/> No
Vibration	<input type="checkbox"/> Yes	<input type="checkbox"/> No
Leaks	<input type="checkbox"/> Yes	<input type="checkbox"/> No
Pressure maintenance pump installed	<input type="checkbox"/> Yes	<input type="checkbox"/> No
Name plate and markings visible	<input type="checkbox"/> Yes	<input type="checkbox"/> No
Correct identification of all valves	<input type="checkbox"/> Yes	<input type="checkbox"/> No
Gauges installed and functional	<input type="checkbox"/> Yes	<input type="checkbox"/> No
Verify alarm signals received at Communications Center	<input type="checkbox"/> Yes	<input type="checkbox"/> No
Certificate of test transferred to EHS	<input type="checkbox"/> Yes	<input type="checkbox"/> No
O&M manual transferred to TAMU personnel	<input type="checkbox"/> Yes	<input type="checkbox"/> No
Other:	<input type="checkbox"/> Yes	<input type="checkbox"/> No

Comments:

**Attachment VIII
Fire Sprinkler Aboveground
Contractor's Test Materials (TDI-SFM)**



TEXAS DEPARTMENT OF INSURANCE

State Fire Marshal's Office (112-FM)

333 Guadalupe, Austin, Texas 78701 * PO Box 149221, Austin, Texas 78714-9221
 (512) 676-6800 | F: (512) 490-1063 | (800) 578-4677 | TDI.texas.gov | @TXSFMO

Contractor's Material and Test Certificate for Aboveground Piping

PROCEDURE

Upon completion of work, inspection and tests shall be made by the contractor's representative and witnessed by an owner's representative. All defects shall be corrected and system left in service before contractor's personnel finally leave the job.

A certificate shall be filled out and signed by both representatives. Copies shall be prepared for approving authorities, owners and the contractor. It is understood the owner's representative's signature in no way prejudices any claim against contractor for faulty material, poor workmanship, or failure to comply with approving authorities requirements or local ordinances.

Property Name	Date
---------------	------

Property Address	City	State	Zip
------------------	------	-------	-----

PLANS	Accepted by approving authorities(names)		
	Address		
	Installation conforms to accepted plans	<input type="checkbox"/> Yes	<input type="checkbox"/> No
	Equipment used is approved? If no, explain deviations	<input type="checkbox"/> Yes	<input type="checkbox"/> No

INSTRUCTIONS	Has person in charge of fire equipment been instructed as to location of control valves and care and maintenance of this new equipment? If no, explain		<input type="checkbox"/> Yes	<input type="checkbox"/> No
	Have copies of the following been left on the premises? 1. System Components Instructions 2. Care and Maintenance Instructions 3. NFPA 25		<input type="checkbox"/> Yes	<input type="checkbox"/> No

LOCATION OF SYSTEM	Supplies buildings
---------------------------	--------------------

SPRINKLERS	Make	Model	Year of Manufacture	Orifice Size	Quantity	Temperature Rating

PIPE AND FITTINGS	Type of pipe
	Type of fittings

ALARM VALVE OR FLOW INDICATOR	ALARM DEVICES			Maximum time to operate through test connection	
	Type	Make	Model	Minutes	Seconds

DRY PIPE OPERATING TEST	DRY VALVE				Q.O.D.				
	Make	Model	Serial No.	Make	Model	Serial No.			
		Time to trip through test connection ^{1,2}	Water Pressure	Air Pressure	Trip Point Air Pressure	Time water reached test outlet ^{1,2}	Alarm operated properly		
		Minutes Seconds	psi	psi	psi	Minutes Seconds	Yes No		
	Without Q.O.D.								
	With Q.O.D.								
	If no, explain								

DELUGE & PREACTION VALVES	Operation		<input type="checkbox"/> Pneumatic	<input type="checkbox"/> Electric	<input type="checkbox"/> Hydraulic		
	Piping supervised		<input type="checkbox"/> Yes	<input type="checkbox"/> No	Detection media supervised	<input type="checkbox"/> Yes	<input type="checkbox"/> No
	Does valve operate from the manual trip, remote, or both control stations?		<input type="checkbox"/> Yes	<input type="checkbox"/> No			
	Is there an accessible facility in each circuit for testing?		<input type="checkbox"/> Yes	<input type="checkbox"/> No	If no, explain		
	Make	Model	Does each circuit operate supervision loss alarm?		Does each circuit operate valve release?		Maximum time to operate release?
		Yes	No	Yes	No	Minutes	Seconds

¹ Measured from time inspector's test connection is opened. ² NFPA 13 only requires the 60-second limitation in specific sections

PRESSURE REDUCING VALVE TEST	Location	Make & Model	Setting	STATIC PRESSURE		RESIDUAL PRESSURE		FLOW
				Inlet (psi)	Outlet	Inlet (psi)	Outlet (psi)	Flow
TEST DESCRIPTION	<p>HYDROSTATIC: Hydrostatic tests shall be made at not less than 200 psi (13.6 bars) for two hours or 50 psi (3.4 bars) above static pressure in excess of 150 psi (10.2 bars) for two hours. Differential Dry-Pipe Valve clappers shall be left open during test to prevent damage. All aboveground piping leakage shall be stopped.</p> <p>PNEUMATIC: Establish 40 psi (2.7 bars) air pressure and measure drop, which shall not exceed 1-1/2 psi (0.1 bars) in 24 hours. Test pressure tanks at normal water level and air pressure and measure air pressure drop, which shall not exceed 1-1/2 psi (0.1 bars) in 24 hours.</p>							
TESTS	All pipe hydraulically tested at: _____ psi (_____ bar) for _____ hrs			If no, state reason				
	Dry Pipe pneumatically tested <input type="checkbox"/> Yes <input type="checkbox"/> No							
	Equipment operates properly <input type="checkbox"/> Yes <input type="checkbox"/> No							
	Do you certify as the sprinkler contractor that additives and corrosive chemicals, sodium silicate or derivatives of sodium silicate, brine, or other toxic chemicals were not used for testing systems or stopping leaks? <input type="checkbox"/> Yes <input type="checkbox"/> No							
	DRAIN	Reading of gage located near water supply test connection: _____ psi (_____ bar)			Residual pressure with valve in test connection open wide. _____ psi (_____ bar)			
Underground mains and lead in connections to system risers flushed before connection made to sprinkler piping								
Verified by copy of the Contractor's Material & Test Certificate for Underground Piping. <input type="checkbox"/> Yes <input type="checkbox"/> No			Other, explain					
Flushed by installer of underground sprinkler piping. <input type="checkbox"/> Yes <input type="checkbox"/> No								
If powder driven fasteners are used in concrete, has representative sample testing been satisfactorily completed? <input type="checkbox"/> Yes <input type="checkbox"/> No				If no, explain				
BLANK TESTING GASKETS	Number used	Locations					Number removed	
WELDING	Welded piping <input type="checkbox"/> Yes <input type="checkbox"/> No			If yes...				
	Do you certify as the sprinkler contractor that welding procedures comply with the requirements of at least AWS B2.1? <input type="checkbox"/> Yes <input type="checkbox"/> No							
	Do you certify that the welding was performed by welders qualified in compliance with the requirements of at least AWS B2.1? <input type="checkbox"/> Yes <input type="checkbox"/> No							
	Do you certify that the welding was carried out in compliance with a documented quality control procedure to ensure that all discs are retrieved, that openings in piping are smooth, that slag and other welding residue are removed, and that the internal diameters of piping are not penetrated? <input type="checkbox"/> Yes <input type="checkbox"/> No							
CUTOUTS (DISCS)	Do you certify that you have a control feature to ensure that all cutouts (disks) are retrieved? <input type="checkbox"/> Yes <input type="checkbox"/> No							
HYDRAULIC DATA NAMEPLATE	Nameplate provided? <input type="checkbox"/> Yes <input type="checkbox"/> No			If no, explain				
REMARKS	DATE left in service with all control valves open: _____							
Signature	Name of sprinkler contractor					C of R No. SCR-		
	Contractor's Address				City		State	Zip
	Tests witnessed by							
	For property owner (signed)			Title			Date	
	For sprinkler contractor (signed)			Title			Date	
Additional explanation and notes								

RME CERTIFICATION	I certify that the information herein is true and that this sprinkler system was installed in accordance with Chapter 6003, Texas Insurance Code and the rules and standards adopted by the State Fire Marshal's Office.							
	Responsible Managing Employee (signature)							
	Responsible Managing Employee (print or type name)							
RME License Number					Date			

DISTRIBUTION: Original COPY 1 Posted at site or give to owner COPY 2 for the installing firm in file accessible to SFMO
COPY 3 for local approving authority within 10 days after completion

**Attachment IX
Fire Sprinkler Underground
Contractor's Test Materials (TDI-SFM)**



Contractor's Material and Test Certificate for **U**nderground Piping

PROCEDURE

Upon completion of work, inspection and tests shall be made by the contractor's representative and witnessed by an owner's representative. All defects shall be corrected and system left in service before contractor's personnel finally leave the job.

A certificate shall be filled out and signed by both representatives. Copies shall be prepared for approving authorities, owners, and the contractor. It is understood the owner's representative's signature in no way prejudices any claim against contractor for faulty material, poor workmanship, or failure to comply with approving authority's requirements or local ordinances.

Property Name	Date
---------------	------

Property Address	City	State	Zip
------------------	------	-------	-----

PLANS	Accepted by approving authorities (names)		
	Address		
	Installation conforms to accepted plans	<input type="checkbox"/> Yes	<input type="checkbox"/> No
	Equipment used is approved If no, state deviations	<input type="checkbox"/> Yes	<input type="checkbox"/> No

INSTRUCTIONS	Has person in charge of fire equipment been instructed as to location of control valves and care and maintenance of this new equipment? If no, explain			<input type="checkbox"/> Yes	<input type="checkbox"/> No
	Have copies of appropriate instructions and care and maintenance charts been left on premises? If no, explain			<input type="checkbox"/> Yes	<input type="checkbox"/> No

LOCATION	Supplies buildings
-----------------	--------------------

UNDERGROUND PIPES AND JOINTS	Pipe types and class	Type joints		
	Pipe conforms to _____ Standard	<input type="checkbox"/> Yes	<input type="checkbox"/> No	
	Fittings conform to _____ Standard If no, explain	<input type="checkbox"/> Yes	<input type="checkbox"/> No	
	Joints needed anchorage clamped, strapped or blocked in accordance with _____ standard If no, explain		<input type="checkbox"/> Yes	<input type="checkbox"/> No

TEST DESCRIPTION	FLUSHING: Flow the required rate until water is clear as indicated by no collection of foreign material in burlap bags at outlets such as hydrants and blow-offs. Flush at flows not less than 390 GPM (1476 L/min) for 4-inch pipe, 880 GPM (3331 L/min) for 6-inch pipe, 1560 GPM (5905 L/min) for 8-inch pipe, 2440 GPM (9235 L/min) for 10-inch pipe, and 3520 GPM (13323 L/min) for 12-inch pipe. When supply cannot produce stipulated flow rates, obtain maximum available.		
	HYDROSTATIC: Hydrostatic tests shall be made at not less than 200 psi (13.8 bars) for two hours or 50 psi (3.4 bars) above static pressure in excess of 150 psi (10.3 bars) for two hours.		
	LEAKAGE: New pipe laid with rubber gasketed joints shall, if the workmanship is satisfactory, have little or no leakage at the joints. The amount of leakage at the joints shall not exceed 2 quarts per hour (1.89 L/hr) per 100 joints irrespective of pipe diameter. The leakage shall be distributed over all joints. If such leakage occurs at a few joints, the installation shall be considered unsatisfactory and necessary repairs made. The amount of allowable leakage specified above can be increased by 1 fl oz per inch valve diameter per hour (30 mL/25 mm/hr) for each metal seated valve isolating the test section. If dry barrel hydrants are tested with the main valve open so the hydrants are under pressure, an additional 5 oz per minute (150 mL/min) leakage is permitted for hydrant.		

FLUSHING TESTS	New underground piping flushed according to _____ standard by (company) If no, explain			<input type="checkbox"/> Yes	<input type="checkbox"/> No
	How flushing flow was obtained <input type="checkbox"/> Public water <input type="checkbox"/> Tank or reservoir <input type="checkbox"/> Fire pump		Through what type of opening <input type="checkbox"/> Hydrant butt <input type="checkbox"/> Open pipe		
	Lead-ins flushed according to _____ standard by (company) If no, explain			<input type="checkbox"/> Yes	<input type="checkbox"/> No
	How flushing flow was obtained <input type="checkbox"/> Public water <input type="checkbox"/> Tank or reservoir <input type="checkbox"/> Fire pump		Through what type of opening <input type="checkbox"/> Y connection to flange spigot <input type="checkbox"/> Open pipe		

HYDROSTATIC TEST	All new underground piping hydrostatically tested at _____ psi for _____ hours		Joints covered <input type="checkbox"/> Yes <input type="checkbox"/> No		
	Total amount of leakage measured _____ gallons _____ hours				
LEAKAGE TEST	Allowable leakage _____ gallons _____ hours				
	Number installed	Type and make	All operate satisfactorily <input type="checkbox"/> Yes <input type="checkbox"/> No		
CONTROL VALVES	Water control valves left wide open If no, state reason		<input type="checkbox"/> Yes <input type="checkbox"/> No		
	Hose threads of fire department connections and hydrants interchangeable with those of the fire department answering alarm		<input type="checkbox"/> Yes <input type="checkbox"/> No		
REMARKS	Date left in service _____				
	_____ _____				
Signature	Name of installing contractor		C of R No. SCR-		
	Contractor's Address		City	State	Zip
	Tests witnessed by				
	For property owner (signed)		Title	Date	
	For Installing contractor (signed)		Title	Date	
Additional explanation and notes					

RME CERTIFICATION	I certify that the information herein is true and that this portion of the sprinkler system was installed in accordance with Chapter 6003, Texas Insurance Code and the rules and standards adopted by the State Fire Marshal's Office.	
	Responsible Managing Employee (signature)	
	Responsible Managing Employee (print or type name)	
	RME License Number	Date

DISTRIBUTION: Original COPY 1 Posted at site or give to owner COPY 2 for the installing firm in file accessible to SFMO
COPY 3 for local approving authority within 10 days after completion

Attachment X
Dry Pipe Sprinkler System
Acceptance Checklist

Dry Pipe Sprinkler System Acceptance Test Checklist



Building #: _____ **Building Name:** _____ **Date:** _____

Attendees: _____

Project Number: _____

Location of Riser(s): _____

Type of System: _____ **Location of Spare Heads/Wrench/ Box:** _____

Coverage: Total Partial **Location if Partial:** _____

Sprinkler Heads:

Make	Model	Year	Orifice	Quantity	Temp Rating

Backflow Prevention:

Type: _____ Mfg: _____ Serial #: _____ Size: _____ PSI: _____

Requirements Before Acceptance Test

- Building construction is complete; All trades and cleanup is complete;
Clean-up is Complete Yes No
- Fire protection and life safety systems integrated with fire alarm system
complete and pre-tested Yes No
- All devices verified/correct address/location shown on as built drawings Yes No

Required Documentation at Time of Acceptance Test:

- Underground Certification - **Copy to EHS** Yes No
- Aboveground Certification - **Copy to EHS** Yes No
- O&M Manual Transferred to **AM Personnel** Yes No
- Backflow Valve Certification. Forward flow Tested - **Copy to EHS** Yes No

Acceptance Test

2-Hour Full System Hydrostatic Pressure Test	<input type="checkbox"/> Yes	<input type="checkbox"/> No	<input type="checkbox"/> N/A
40psi, 24hr Pressure Test	<input type="checkbox"/> Yes	<input type="checkbox"/> No	<input type="checkbox"/> N/A
Correct Identification of all Valves	<input type="checkbox"/> Yes	<input type="checkbox"/> No	<input type="checkbox"/> N/A
Gauges Installed and Functional	<input type="checkbox"/> Yes	<input type="checkbox"/> No	<input type="checkbox"/> N/A
Low Temp. Alarm in Valve Enclosures	<input type="checkbox"/> Yes	<input type="checkbox"/> No	<input type="checkbox"/> N/A
Valve Room Lighted & Heated	<input type="checkbox"/> Yes	<input type="checkbox"/> No	<input type="checkbox"/> N/A
Verify Installation of Storage Box	<input type="checkbox"/> Yes	<input type="checkbox"/> No	<input type="checkbox"/> N/A
Appropriate # & type of spare heads/fusible heat responsive devices/sprinkler wrench <input type="checkbox"/> Minimum 2 of each type <input type="checkbox"/> 1-300 = Minimum 6 <input type="checkbox"/> 300-1000 = Minimum 12 <input type="checkbox"/> Over 1000 = Minimum 24	<input type="checkbox"/> Yes	<input type="checkbox"/> No	<input type="checkbox"/> N/A
Verify Check Valves Installed On Each Independent System	<input type="checkbox"/> Yes	<input type="checkbox"/> No	<input type="checkbox"/> N/A
Appropriate System Air Pressure-15-20psi Over Operating	<input type="checkbox"/> Yes	<input type="checkbox"/> No	<input type="checkbox"/> N/A
Functional test of all Tamper Switches	<input type="checkbox"/> Yes	<input type="checkbox"/> No	<input type="checkbox"/> N/A
Full Flow Trip Valve Test (NFPA 13:7.2.3.6.1)	<input type="checkbox"/> Yes	<input type="checkbox"/> No	<input type="checkbox"/> N/A
Alarm Valve Test-Will Sound Water Gong	<input type="checkbox"/> Yes	<input type="checkbox"/> No	<input type="checkbox"/> N/A
Automatic Air Maintenance Device Test	<input type="checkbox"/> Yes	<input type="checkbox"/> No	<input type="checkbox"/> N/A
Low Air Pressure Alarm Test	<input type="checkbox"/> Yes	<input type="checkbox"/> No	<input type="checkbox"/> N/A
Relief Valve Test- No Less Than 10 PSI In Excess Of Working Pressure	<input type="checkbox"/> Yes	<input type="checkbox"/> No	<input type="checkbox"/> N/A
Main Drain Test of Riser-Flush of System Until Water Runs Clear	<input type="checkbox"/> Yes	<input type="checkbox"/> No	<input type="checkbox"/> N/A
Functional test of all Valves	<input type="checkbox"/> Yes	<input type="checkbox"/> No	<input type="checkbox"/> N/A
Correct Identification of all Valves	<input type="checkbox"/> Yes	<input type="checkbox"/> No	<input type="checkbox"/> N/A
Verify Alarm, Supervisory, Trouble Signals Received at Communications Center	<input type="checkbox"/> Yes	<input type="checkbox"/> No	<input type="checkbox"/> N/A
Required Installation Tag/Documents On Premise <ul style="list-style-type: none"> • Air & water pressure • Tripping air pressure • Dry pipe valve operating condition 	<input type="checkbox"/> Yes	<input type="checkbox"/> No	<input type="checkbox"/> N/A
Post Indicator Valve Open & Locked**	<input type="checkbox"/> Yes	<input type="checkbox"/> No	<input type="checkbox"/> N/A
Knox Caps Installed on FDC***	<input type="checkbox"/> Yes	<input type="checkbox"/> No	<input type="checkbox"/> N/A
Hydraulic Plate Installed	<input type="checkbox"/> Yes	<input type="checkbox"/> No	<input type="checkbox"/> N/A
Other:	<input type="checkbox"/> Yes	<input type="checkbox"/> No	

* As required by NFPA 13 10.10.2.5

** Lock is ordered and installed by TAMU Facilities Services.

*** To be supplied by general contractor

Comments:

Attachment XI
Automatic Sprinkler System
Acceptance Checklist

Automatic Sprinkler System Acceptance Checklist



Building #: _____ **Building Name:** _____ **Date:** _____

Attendees: _____

Project Number: _____

Location of Riser(s): _____

Type of System: _____ **Location of Spare Heads/Wrench/ Box:** _____

Coverage: Total Partial **Location if Partial:** _____

Sprinkler Heads:

Make	Model	Year	Orifice	Quantity	Temp Rating

Backflow Prevention:

Type: _____ **Mfg:** _____ **Serial #:** _____ **Size:** _____ **PSI:** _____

Requirements Before Acceptance Testing:

1. Building construction complete. All Trades complete. Clean-up complete.
2. Fire Protection and life safety system integrated with fire alarm system complete and pre-tested
3. All devices verified with correct address/location shown on as built drawings.
4. Main Drain Test/ Flush of System

Required Documentation at Time of Acceptance Test:

All devices verified with correct address/location shown on as built drawings	<input type="checkbox"/> Yes <input type="checkbox"/> No
System as-built riser diagram	<input type="checkbox"/> Yes <input type="checkbox"/> No
Underground Certification Transferred- 1 Copy To EHS	<input type="checkbox"/> Yes <input type="checkbox"/> No
Aboveground Certification Transferred- 1 Copy To EHS	<input type="checkbox"/> Yes <input type="checkbox"/> No
Backflow Valve Certification. Forward flow Tested (NFPA 13 10.10.2.5)	<input type="checkbox"/> Yes <input type="checkbox"/> No
O&M Manual Transferred to AM Personnel	<input type="checkbox"/> Yes <input type="checkbox"/> No

Acceptance Test

2-Hour full System Pressure Test*	<input type="checkbox"/> Yes	<input type="checkbox"/> No	<input type="checkbox"/> N/A
Functional Test of Fire Pump - Use Fire Pump Test Form (If equipped)	<input type="checkbox"/> Yes	<input type="checkbox"/> No	<input type="checkbox"/> N/A
Verify Installation of Storage Box for Spare Sprinkler Heads in Conditioned Space	<input type="checkbox"/> Yes	<input type="checkbox"/> No	<input type="checkbox"/> N/A
Appropriate Number and Type of Spare Heads/Sprinkler Wrenche(s) <ul style="list-style-type: none"> • Minimum 2 of each type • 1-300 = Minimum 6 • 300-1000 = Minimum 12 • Over 1000 = Minimum 24 	<input type="checkbox"/> Yes	<input type="checkbox"/> No	<input type="checkbox"/> N/A
Gauges Installed (Above & Below Check Valve) and Functional	<input type="checkbox"/> Yes	<input type="checkbox"/> No	<input type="checkbox"/> N/A
Main Drain/Flow Test - Record Residual pressure _____ PSI Static pressure _____ PSI	<input type="checkbox"/> Yes	<input type="checkbox"/> No	<input type="checkbox"/> N/A
Functional Test of All Flow Switches (max 90 seconds)**	<input type="checkbox"/> Yes	<input type="checkbox"/> No	<input type="checkbox"/> N/A
Functional Test of All Tamper Switches	<input type="checkbox"/> Yes	<input type="checkbox"/> No	<input type="checkbox"/> N/A

Functional Test of Water Gong or Bell with Inspectors Test Valve	<input type="checkbox"/> Yes	<input type="checkbox"/> No	<input type="checkbox"/> N/A
Functional Test of All Valves	<input type="checkbox"/> Yes	<input type="checkbox"/> No	<input type="checkbox"/> N/A
Correct Identification of All Valves With Appropriate Signage	<input type="checkbox"/> Yes	<input type="checkbox"/> No	<input type="checkbox"/> N/A
FDC Properly Identified	<input type="checkbox"/> Yes	<input type="checkbox"/> No	<input type="checkbox"/> N/A
Test Header Connections Have Proper Caps	<input type="checkbox"/> Yes	<input type="checkbox"/> No	<input type="checkbox"/> N/A
Post Indicator Valve Open & Locked***	<input type="checkbox"/> Yes	<input type="checkbox"/> No	<input type="checkbox"/> N/A
Knox Caps Installed on FDC****	<input type="checkbox"/> Yes	<input type="checkbox"/> No	<input type="checkbox"/> N/A
General Information Plate Installed	<input type="checkbox"/> Yes	<input type="checkbox"/> No	<input type="checkbox"/> N/A
Hydraulic Plate Installed	<input type="checkbox"/> Yes	<input type="checkbox"/> No	<input type="checkbox"/> N/A
Other: _____	<input type="checkbox"/> Yes	<input type="checkbox"/> No	<input type="checkbox"/> N/A

*** Hydrostatic pressure test shall be in accordance with NFPA 13 25.2.1, 10.10.2.2**

**** Texas A&M preferred time is 30-45 seconds.**

***** Lock is ordered and installed by TAMU Facilities Services.**

****** To be supplied by general contractor.**

Comments:

Attachment XII
Hydrostatic Acceptance Checklist

Hydrostatic Acceptance Checklist



Building #: _____ **Building Name:** _____ **Date:** _____

Attendees: _____

Project Number: _____

Inspector: _____

Type of Test/Hydrostatic Test:

- Underground w/thrust blocks in place
- Aboveground – Sprinkler
- Aboveground - Standpipe

Type of Systems:

- Wet Pipe
- Dry Pipe
- Pre-Action
- Deluge
- Underground
- Combination Wet/Dry

System Pressurized to 200 psi (Water) <input type="checkbox"/> Above ground - 200 psi - no changes in 2 hours <input type="checkbox"/> Underground - 200 psi - no more than 5 psi drop in 2 hours <input type="checkbox"/> Ensure compressor / pump removed from location	<input type="checkbox"/> Yes	<input type="checkbox"/> No	<input type="checkbox"/> N/A
24 Hour Air Pressure Check System Pressurized to 40 psi (Air) <input type="checkbox"/> Above ground - 200 psi - no changes in 2 hours <input type="checkbox"/> Underground - 200 psi - no more than 5 psi drop in 2 hours <input type="checkbox"/> Ensure compressor / pump removed from location	<input type="checkbox"/> Yes	<input type="checkbox"/> No	<input type="checkbox"/> N/A
System Free of Water Leaks (Elbows, Joints, heads, etc.)	<input type="checkbox"/> Yes	<input type="checkbox"/> No	<input type="checkbox"/> N/A
Pipe Hangers Adequately Spaced and Free of Damage <input type="checkbox"/> Loose hangers <input type="checkbox"/> All-thread straight (no bends) <input type="checkbox"/> Within 12" if a fire pump is installed <input type="checkbox"/> Proper distance from end of Piping <ul style="list-style-type: none"> o Armover 12" (>100 psi) o Armover 24" cumulative <100 psi o Pendant - 12" (>100 psi) o Upright - 36" 	<input type="checkbox"/> Yes	<input type="checkbox"/> No	<input type="checkbox"/> N/A
Fire Stopping Performed <input type="checkbox"/> Fire caulk both sides of penetrations <input type="checkbox"/> Sleeves in place <input type="checkbox"/> Escutcheons installed	<input type="checkbox"/> Yes	<input type="checkbox"/> No	<input type="checkbox"/> N/A
Spray Pattern Clear (Note any objects that may interfere with spray pattern) <input type="checkbox"/> Pipe hangers within 3" of head <input type="checkbox"/> Sprinkler head < 4" from wall <input type="checkbox"/> Sprinkler head < 1" from ceiling	<input type="checkbox"/> Yes	<input type="checkbox"/> No	<input type="checkbox"/> N/A
Gauge Zeroed Out	<input type="checkbox"/> Yes	<input type="checkbox"/> No	<input type="checkbox"/> N/A
Water Observed Flowing from Drain	<input type="checkbox"/> Yes	<input type="checkbox"/> No	<input type="checkbox"/> N/A
System Flushed & Observed Clear Water Flowing <input type="checkbox"/> Flow from most remote point in the system through a 2 ½" hose, or largest outlet available for the system	<input type="checkbox"/> Yes	<input type="checkbox"/> No	
Copy of Paperwork Submitted to EHS	<input type="checkbox"/> Yes	<input type="checkbox"/> No	<input type="checkbox"/> N/A
Hydrostatic Test Completed/Passed	<input type="checkbox"/> Yes	<input type="checkbox"/> No	
Other: _____	<input type="checkbox"/> Yes	<input type="checkbox"/> No	<input type="checkbox"/> N/A

Comments:

**Attachment XIII
Pre-action Fire Sprinkler System
Acceptance Checklist**

Pre-Action Sprinkler System Acceptance Checklist



Building #: _____ **Building Name:** _____ **Date:** _____

Attendees: _____

Project Number: _____

Location of Riser(s): _____

Type of System: Non-Interlock Single Interlock Double Interlock

Location of Spare Heads/Wrench/ Box: _____

Coverage: Total Partial **Location if Partial:** _____

Sprinkler Heads:

Make	Model	Year	Orifice	Quantity	Temp Rating

Backflow Prevention:

Type: _____ **Mfg.:** _____ **Serial #:** _____ **Size:** _____ **PSI:** _____

Requirements Before Acceptance Testing:

1. Building construction complete; All trades complete; Clean-up complete
2. Fire protection and life safety system integrated with fire alarm system complete and pre-tested
3. All devices verified with correct address/location shown on as built drawings
4. Main drain test/ Flush of system

Required Documentation at Time of Acceptance Test:

All devices verified with correct address/location shown on as built drawings	<input type="checkbox"/> Yes <input type="checkbox"/> No
System as-built riser diagram	<input type="checkbox"/> Yes <input type="checkbox"/> No
Underground Certification Transferred- 1 Copy to EHS	<input type="checkbox"/> Yes <input type="checkbox"/> No
Aboveground Certification Transferred- 1 Copy to EHS	<input type="checkbox"/> Yes <input type="checkbox"/> No
Backflow Valve Certification. Forward flow Tested (NFPA 13 10.10.2.5)	<input type="checkbox"/> Yes <input type="checkbox"/> No
O&M Manual Transferred to AM Personnel	<input type="checkbox"/> Yes <input type="checkbox"/> No

Acceptance Test

2-Hour full System Pressure Test*	<input type="checkbox"/> Yes	<input type="checkbox"/> No	<input type="checkbox"/> N/A
For Double Interlock System: 24 Hour Air Test at 40 psi for 24 hours. Pressure loss must not be more than 1 ½ psi. Ref: 25.2.2	<input type="checkbox"/> Yes	<input type="checkbox"/> No	<input type="checkbox"/> N/A
Functional Test of Fire Pump - Use Fire Pump Test Form (If Equipped)	<input type="checkbox"/> Yes	<input type="checkbox"/> No	<input type="checkbox"/> N/A
Verify Installation of Storage Box for Spare Sprinkler Heads in Conditioned Space	<input type="checkbox"/> Yes	<input type="checkbox"/> No	<input type="checkbox"/> N/A
Appropriate Number and Type of Spare Heads/Sprinkler Wrench(s) <ul style="list-style-type: none"> • Minimum 2 of each type • 1-300 = Minimum 6 • 300-1000 = Minimum 12 • Over 1000 = Minimum 24 	<input type="checkbox"/> Yes	<input type="checkbox"/> No	<input type="checkbox"/> N/A

Gauges Installed (Above & Below Check Valve) and Functional	<input type="checkbox"/> Yes	<input type="checkbox"/> No	<input type="checkbox"/> N/A
Main Drain/Flow Test - Record	<input type="checkbox"/> Yes	<input type="checkbox"/> No	<input type="checkbox"/> N/A
Residual pressure _____ PSI			
Static pressure _____ PSI			
Functional Test of All Flow Switches (max 90 seconds)**	<input type="checkbox"/> Yes	<input type="checkbox"/> No	<input type="checkbox"/> N/A
Functional Test of All Tamper Switches	<input type="checkbox"/> Yes	<input type="checkbox"/> No	<input type="checkbox"/> N/A
Functional Test of Water Gong/Bell with Inspector Test Valve	<input type="checkbox"/> Yes	<input type="checkbox"/> No	<input type="checkbox"/> N/A
Functional Test of All Valves	<input type="checkbox"/> Yes	<input type="checkbox"/> No	<input type="checkbox"/> N/A
Functional Test of Manual and Remote Control Operations	<input type="checkbox"/> Yes	<input type="checkbox"/> No	<input type="checkbox"/> N/A
Correct Identification of All Valves with Appropriate Signage	<input type="checkbox"/> Yes	<input type="checkbox"/> No	<input type="checkbox"/> N/A
FDC Properly Identified	<input type="checkbox"/> Yes	<input type="checkbox"/> No	<input type="checkbox"/> N/A
Test Header Connections Have Proper Caps	<input type="checkbox"/> Yes	<input type="checkbox"/> No	<input type="checkbox"/> N/A
Post Indicator Valve Open & Locked***	<input type="checkbox"/> Yes	<input type="checkbox"/> No	<input type="checkbox"/> N/A
Knox Caps Installed on FDC****	<input type="checkbox"/> Yes	<input type="checkbox"/> No	<input type="checkbox"/> N/A
General Information Plate Installed	<input type="checkbox"/> Yes	<input type="checkbox"/> No	<input type="checkbox"/> N/A
Hydraulic Plate Installed	<input type="checkbox"/> Yes	<input type="checkbox"/> No	<input type="checkbox"/> N/A
Other: _____	<input type="checkbox"/> Yes	<input type="checkbox"/> No	<input type="checkbox"/> N/A

* Hydrostatic pressure test shall be in accordance with NFPA 13 25.2.1, 10.10.2.2

** Texas A&M preferred time is 30-45 seconds.

*** Lock is ordered and installed by TAMU Facilities Services.

**** To be supplied by general contractor.

Comments:

**Attachment XIV
Deluge Fire Sprinkler System
Acceptance Checklist**

Deluge Sprinkler System Acceptance Checklist



Building #: _____ **Building Name:** _____ **Date:** _____

Attendees: _____

Project Number: _____

Location of Riser(s): _____

Type of System: _____ **Location of Spare Heads/Wrench/ Box:** _____

Coverage: Total Partial **Location if Partial:** _____

Sprinkler Heads:

Make	Model	Year	Orifice	Quantity	Temp Rating

Backflow Prevention:

Type: _____ **Mfg.:** _____ **Serial #:** _____ **Size:** _____ **PSI:** _____

Requirements Before Acceptance Testing:

1. Building construction complete. All Trades complete. Clean-up complete.
2. Fire Protection and life safety system integrated with fire alarm system complete and pre-tested
3. All devices verified with correct address/location shown on as built drawings.
4. Main Drain Test/ Flush of System

Required Documentation at Time of Acceptance Test:

All devices verified with correct address/location shown on as built drawings	<input type="checkbox"/> Yes <input type="checkbox"/> No
System as-built riser diagram	<input type="checkbox"/> Yes <input type="checkbox"/> No
Underground Certification Transferred- 1 Copy to EHS	<input type="checkbox"/> Yes <input type="checkbox"/> No
Aboveground Certification Transferred- 1 Copy to EHS	<input type="checkbox"/> Yes <input type="checkbox"/> No
Backflow Valve Certification. Forward flow Tested (NFPA 13 10.10.2.5)	<input type="checkbox"/> Yes <input type="checkbox"/> No
O&M Manual Transferred to AM Personnel	<input type="checkbox"/> Yes <input type="checkbox"/> No

Acceptance Test

2-Hour full System Pressure Test*	<input type="checkbox"/> Yes	<input type="checkbox"/> No	<input type="checkbox"/> N/A
Functional Test of Fire Pump - Use Fire Pump Test Form (If equipped)	<input type="checkbox"/> Yes	<input type="checkbox"/> No	<input type="checkbox"/> N/A
Verify Installation of Storage Box for Spare Sprinkler Heads in Conditioned Space	<input type="checkbox"/> Yes	<input type="checkbox"/> No	<input type="checkbox"/> N/A
Appropriate #/Type of Spare Heads/Sprinkler Wrench <ul style="list-style-type: none"> • Minimum 2 of each type • 1-300 = Minimum 6 • 300-1000 = Minimum 12 • Over 1000 = Minimum 24 	<input type="checkbox"/> Yes	<input type="checkbox"/> No	<input type="checkbox"/> N/A
Gauges installed (Above & Below Check Valve) and Functional	<input type="checkbox"/> Yes	<input type="checkbox"/> No	<input type="checkbox"/> N/A
Main Drain/Flow Test - Record Residual Pressure _____ PSI Static Pressure _____ PSI	<input type="checkbox"/> Yes	<input type="checkbox"/> No	<input type="checkbox"/> N/A

**Attachment XV
Fuel Gas Test Form**

Fuel Gas Test Form



This form is required to be completed for any new installation, modification, or required testing of any fuel gas system on the Texas A&M University (TAMU) Campuses.

Date of Test: ____/____/____ **Work Request #:** _____
Previous Test Date: ____/____/____ **Type of Gas:** _____
Meter Number: _____
Facility Name: _____ **Facility #:** _____
Facility Address: _____ **Room #:** _____
Location of Gas Pipe: _____
Testing Company: _____ **Phone #:** _____
Tested by: _____ **License #:** _____
(Please Print)

TAMU SSC Contractor (Circle One)

Start Time	am/pm	Start Temperature	
End Time	am/pm	End Temperature	
Survey	Pressure (Use Diaphragm Type Gauge)		
Detector <input type="checkbox"/>	Low Pressure (LP): [1 psi or less] 5 psi for 30 min		
	Intermediate Pressure (IP): 10 psi or Relieve Valve Opening Point for 1 hour		
Bubbles <input type="checkbox"/>		Start Pressure	
		End Pressure	

Test Results: Pass Fail **Repairs Required?** Yes No

Comments:

Verifying Official: _____ **Date:** ____/____/____

Witnessed by: _____ **Date:** ____/____/____
(TAMU or SSC representative)

Submit Completed and Signed form to:
 TAMU EHS
 MS 4472 TAMU

Attachment XVI
Kitchen Hood and Duct Extinguishing System
Acceptance Test Checklist

Attachment XVII
Fixed Extinguishing System Installation Certificate
SFM-TDI Form FML-010



TEXAS DEPARTMENT OF INSURANCE

State Fire Marshal's Office (112-FM)
333 Guadalupe, Austin, Texas 78701 * PO Box 149221, Austin, Texas 78714-9221
(512) 676-6800 | F: (512) 490-1063 | (800) 578-4677 | TDI.texas.gov | @TXSFMO

INSTALLING COMPANY

Address:
City: Zip
Phone:
Company Certificate of Registration Number

PROTECTED PROPERTY

Name:
Street Address: City: Zip:
Owner or Owner's representative instructed on system operation & maintenance:
Owners Rep, if applicable: Yes No

LOCAL AUTHORITY HAVING JURISDICTION

Name:
Street Address: City: Zip:

HAZARD ANALYSIS

Name of area, room, building or hazard protected

Primary Class of Protected Hazard

- Class A - Wood, paper, etc.
Class B - Flammable liquids
Class C - Electrical equipment
Class D - Combustible metals
Explosives

Kitchen Hoods & Appliance System

Table with columns: Overall Hood, Plenum, Exhaust duct perimeter, Appliances (Protected, Gas or Elect), Qty, Height, Length, Width. Includes rows for Deep Fat Fryer, Range, Griddle, Char Broiler, Radiant Broiler, Upright Broiler.

Other Type Hazards

Is hazard normally occupied? Yes No N/A
Size of Hazard: Total Volume or Total Area. Height, Length, Width. Area sealed to prevent agent loss? Number of room air changes per minute? Warning & instruction signs posted?

SYSTEM INFORMATION

System Manufacturer's Name:
Installation Manual: UL Number: Date:
Design type: Pre-engineered: Engineered:
If Pre-engineered, Model Number
Coverage Type: Total Flooding: Local App:
System Actuation: Automatic: Manual:
Air/Fan shutdown on actuation? Yes: No:
Design discharge rate or concentration level:
Design discharge time: Seconds:

AGENT INFORMATION

Type of agent provided:
City Storage cylinder Manufacturer Part No. Amount of agent

EQUIPMENT INFORMATION

Table with columns: Initiating Devices, Qty, Item, Manufacturer, Part No., Temperature. Includes rows for Fusible Links, Sprinkler Heads, Heat Detectors, Smoke Detectors, Other Fire Detectors, Manual Pull Stations, Nozzles, Interlock, Fan or A/C Shutdown, Gas line Shut-off, Electric Shut-off.

TESTING

Method system was tested:
I certify that this fixed fire extinguishing system has been tested and complies with the requirements of Chapter 6001 of the Texas Insurance Code, as amended, and the fire extinguisher rules and adopted NFPA Standards.

This system was installed in accordance with the following codes:
NFPA Year
NFPA Year

Signature of Licensee & License Number
Completion Date

Reproduce Form & Distribute
Original to Protected Premise
Copy 1 to Installing Contractor
Copy 2 Certifying Firm for
for access by SFMO
Form # FML 010 July 2015
SF205 Rev. 07/15

Attachment XVIII
Smoke Management Systems Acceptance Form

Smoke Management Systems Acceptance Checklist



Building #: _____ **Building Name:** _____ **Date:** _____

System Info: _____

Attendees: _____

Project Number: _____ **System Location:** _____

Requirements Before Acceptance Testing:

- All system components should be thoroughly tested
- Fire protection and life safety system integrated with fire alarm system complete and pre-tested

Required Documentation at Time of Acceptance Test:

- Construction documents should be readily available (detailed design report and O & M manual)
- Construction documents shall include all acceptance testing procedures and pass/fail criteria

General Procedures:

1. Prior to performance testing, inspectors will verify the exact location of the perimeter of each large-volume space smoke management system, identify any door openings into that space, and identify all adjacent areas that are to remain open and that are to be protected by airflow alone.
2. System testing of smoke control systems shall include all equipment such as initiating devices, fans, dampers, controls, doors and windows. Tests shall be performed on primary and standby power conditions.

Acceptance Test

Activate the Smoke Management System (Primary Power)	<input type="checkbox"/> Yes	<input type="checkbox"/> No	<input type="checkbox"/> N/A
Verify the Operation of All Fans	<input type="checkbox"/> Yes	<input type="checkbox"/> No	<input type="checkbox"/> N/A
Verify the Operation of All Dampers	<input type="checkbox"/> Yes	<input type="checkbox"/> No	<input type="checkbox"/> N/A
Verify the Operation of All Doors	<input type="checkbox"/> Yes	<input type="checkbox"/> No	<input type="checkbox"/> N/A
Verify the Operation of Related Equipment	<input type="checkbox"/> Yes	<input type="checkbox"/> No	<input type="checkbox"/> N/A
Measure Fan Exhaust Capacities	<input type="checkbox"/> Yes	<input type="checkbox"/> No	<input type="checkbox"/> N/A
Measure Air Velocities of Supply Grilles	<input type="checkbox"/> Yes	<input type="checkbox"/> No	<input type="checkbox"/> N/A
Measure Force Needed to Open Exit Doors	<input type="checkbox"/> Yes	<input type="checkbox"/> No	<input type="checkbox"/> N/A
Measure and Record Pressure Difference Across All Doors That Separate the Smoke Management Area From Adjacent Spaces	<input type="checkbox"/> Yes	<input type="checkbox"/> No	<input type="checkbox"/> N/A
Verify Alarm, Supervisory and Trouble Signals Received at the Communications Center	<input type="checkbox"/> Yes	<input type="checkbox"/> No	<input type="checkbox"/> N/A
Verify System Operation in Standby Power Conditions	<input type="checkbox"/> Yes	<input type="checkbox"/> No	<input type="checkbox"/> N/A
Exhaust Air information: _____ Number of fans: _____ CFM per fan: _____ RPM's required for each fan to achieve required CFM: _____ Total CFM provided by fans: _____	<input type="checkbox"/> Yes	<input type="checkbox"/> No	<input type="checkbox"/> N/A
Make-up Air Information: Total sq. ft. of makeup air required: _____ Make up air provided by (circle one) <ul style="list-style-type: none"> • Louvers • Overhead doors • Personnel doors • Other Number of openings and number of square feet each: _____	<input type="checkbox"/> Yes	<input type="checkbox"/> No	<input type="checkbox"/> N/A
Verify Manual Means of Starting/Stopping System	<input type="checkbox"/> Yes	<input type="checkbox"/> No	<input type="checkbox"/> N/A
O & M Manual/Special Tools Transferred to TAMU	<input type="checkbox"/> Yes	<input type="checkbox"/> No	<input type="checkbox"/> N/A
Other: _____			

Code References:

NFPA 92 B. Smoke Management Systems in Malls, Atria, and Large Spaces

92B A.8.2.3 Operational testing of system components should be completed during construction. It should be documented in writing that each individual system component's installation is complete and the component is functional.

8.3.5.2 Acceptance testing to verify system performance shall include the following:

1. Prior to performance testing, verify the exact location of the perimeter of each large-volume space smoke management system, identify any door openings into that space, and identify all adjacent areas that are to remain open and that are to be protected by airflow alone.
2. Activate the smoke management system. Verify and record the operation of all fans, dampers, doors and related equipment. Measure fan exhaust capacities and air velocities through inlet doors and grills or at supply grills if there is a mechanical makeup air system. Measure the force to open exit doors.
3. Where appropriate, measure and record the pressure difference across all doors that separate the smoke management system area from adjacent spaces and the velocities at interfaces with open areas.

A.8.3.1 The following equipment might be needed to perform acceptance testing:

1. Differential pressure gauges, inclined water manometers, or electronic manometers.
2. Scale suitable for measuring door-opening force
3. Anemometer
4. Ammeter and voltmeter
5. Tissue paper roll or other device for indicating direction of airflow
6. Door wedges
7. Signs indicating that a test is in progress
8. Radios or other means of communication to help coordinate equipment operation.

Comments:

**Attachment XIX
Smoke Management Systems
Stairwell Pressurization System
Acceptance Checklist**

**Smoke Management Systems
Stairwell Pressurization System
Acceptance Checklist**



Building #: _____ **Building Name:** _____ **Date:** _____

System Info: _____

Attendees: _____

Project Number: _____

System Location: _____

Stair Door		Building In Normal Mode		Building in Smoke Control Mode					
		Force to Open Door (PSI)		Pressure Difference	Force to Open Door (PSI)		Pressure Difference with Doors Closed	Pressure Difference with 2 Doors Open	Pressure Difference with 3 Doors Open*
Floor	Stair	Push	Pull		Push	Pull			

***Expand form as needed to comply with engineered design requirements**

The forces required to fully open any door leaf manually in a means of egress shall not exceed 15 lbf to release the latch, 30 lbf to set the leaf in motion, and 15 lbf to open the leaf to the minimum required width, unless otherwise specified as follows:

- The opening forces for interior side-hinged or pivoted-swinging door leaves without closers shall not exceed 5 lbf .
- The opening forces for existing door leaves in existing buildings shall not exceed 50 lbf applied to the latch stile.
- The opening forces for horizontal-sliding door leaves in detention and correctional occupancies shall be as provided in Chapters 22 and 23.
- The opening forces for power-operated door leaves shall be as provided in 7.2.1.9.

Attachment XX
Standpipe and Hose Valve System
Acceptance Checklist

Standpipe and Hose Valve System Acceptance Checklist



Building #: _____ **Building Name:** _____ **Date:** _____

Attendees: _____

Project Number: _____

Location of Riser(s): _____

Type of System: Wet Dry

Coverage: Total Partial **Location if Partial:** _____

FDC Location: _____

Pressure Reducing Devices Installed: Yes No
Type: _____
Location: _____
Pressure: _____
Factory or Field Set: _____

Backflow Prevention:

Type: _____ **Mfg.:** _____ **Serial #:** _____ **Size:** _____ **PSI:** _____

Acceptance Test

2-Hour Full System Pressure Test 200 PSI	<input type="checkbox"/> Yes	<input type="checkbox"/> No	<input type="checkbox"/> N/A
Correct Identification of All Valves With Appropriate Signage	<input type="checkbox"/> Yes	<input type="checkbox"/> No	<input type="checkbox"/> N/A
FDC Properly Identified	<input type="checkbox"/> Yes	<input type="checkbox"/> No	<input type="checkbox"/> N/A
Fire Hose Connection Caps Installed/With Chains	<input type="checkbox"/> Yes	<input type="checkbox"/> No	<input type="checkbox"/> N/A
Fire Hose Connections	<input type="checkbox"/> Yes	<input type="checkbox"/> No	<input type="checkbox"/> N/A
<input type="checkbox"/> Located between 45 and 135 degrees from horizontal			
<input type="checkbox"/> Adequate distance from walls/rails			
<input type="checkbox"/> Between 3' and 5' above floor level			
Flow Test Most Hydraulically Remote Standpipe to Verify Design Flow	<input type="checkbox"/> Yes	<input type="checkbox"/> No	<input type="checkbox"/> N/A
Freeze Protection Installed/Tested	<input type="checkbox"/> Yes	<input type="checkbox"/> No	<input type="checkbox"/> N/A
Functional Test of All Flow Switches (30-45 seconds preferred)	<input type="checkbox"/> Yes	<input type="checkbox"/> No	<input type="checkbox"/> N/A
Functional Test of All Tamper Switches	<input type="checkbox"/> Yes	<input type="checkbox"/> No	<input type="checkbox"/> N/A
Functional Test of All Valves	<input type="checkbox"/> Yes	<input type="checkbox"/> No	<input type="checkbox"/> N/A
Functional Test of Fire Pump - Use fire pump test form (If provided)	<input type="checkbox"/> Yes	<input type="checkbox"/> No	<input type="checkbox"/> N/A
Functional Test of Water Gong/Electric Bell w/Inspectors Test Valve	<input type="checkbox"/> Yes	<input type="checkbox"/> No	<input type="checkbox"/> N/A
Gauges	<input type="checkbox"/> Yes	<input type="checkbox"/> No	<input type="checkbox"/> N/A
<input type="checkbox"/> Installed (above & below check valve) and functional			
<input type="checkbox"/> Installed at top of most remote riser			
General Information Plate Installed	<input type="checkbox"/> Yes	<input type="checkbox"/> No	<input type="checkbox"/> N/A
Hose Cabinets	<input type="checkbox"/> Yes	<input type="checkbox"/> No	<input type="checkbox"/> N/A
<input type="checkbox"/> Labeled			
<input type="checkbox"/> Positioned for ease of connection			
Hydraulic Plate Installed	<input type="checkbox"/> Yes	<input type="checkbox"/> No	<input type="checkbox"/> N/A
Knox Caps Transferred to EHS	<input type="checkbox"/> Yes	<input type="checkbox"/> No	<input type="checkbox"/> N/A
Main Drain/Flow Test – record	<input type="checkbox"/> Yes	<input type="checkbox"/> No	<input type="checkbox"/> N/A
Residual pressure _____ PSI			
Static pressure _____ PSI			
Piping Adequately Supported	<input type="checkbox"/> Yes	<input type="checkbox"/> No	
Post Indicator Valve Open & Locked	<input type="checkbox"/> Yes	<input type="checkbox"/> No	<input type="checkbox"/> N/A
Test Header Connections Have Appropriate Caps	<input type="checkbox"/> Yes	<input type="checkbox"/> No	<input type="checkbox"/> N/A
Other: _____	<input type="checkbox"/> Yes	<input type="checkbox"/> No	<input type="checkbox"/> N/A

**Attachment XXI
EHS Project
Final Completion Checklist**

TAMU Project Final Completion Checklist



Building #: _____ **Building Name:** _____ **Date:** _____

Street Address: _____

Project Number: _____

Egress <input type="checkbox"/> Emergency lighting <input type="checkbox"/> Exit signage <input type="checkbox"/> Public way	<input type="checkbox"/> Yes	<input type="checkbox"/> No	<input type="checkbox"/> N/A
Elevators	<input type="checkbox"/> Yes	<input type="checkbox"/> No	<input type="checkbox"/> N/A
Emergency Lighting/Exit Signs	<input type="checkbox"/> Yes	<input type="checkbox"/> No	<input type="checkbox"/> N/A
Emergency Power Supply Systems	<input type="checkbox"/> Yes	<input type="checkbox"/> No	<input type="checkbox"/> N/A
Fire Detection Systems <input type="checkbox"/> Fire alarm systems	<input type="checkbox"/> Yes	<input type="checkbox"/> No	<input type="checkbox"/> N/A
Fire Doors/Curtains/Shutters	<input type="checkbox"/> Yes	<input type="checkbox"/> No	<input type="checkbox"/> N/A
Fire Extinguishers	<input type="checkbox"/> Yes	<input type="checkbox"/> No	<input type="checkbox"/> N/A
Fire Hydrants	<input type="checkbox"/> Yes	<input type="checkbox"/> No	<input type="checkbox"/> N/A
Fire Lanes/Aerial Access Roads	<input type="checkbox"/> Yes	<input type="checkbox"/> No	<input type="checkbox"/> N/A
Fire Suppression Systems <input type="checkbox"/> Clean agent systems <input type="checkbox"/> Deluge sprinkler systems <input type="checkbox"/> Dry sprinkler systems <input type="checkbox"/> FDC Knox caps <input type="checkbox"/> Fire department connections <input type="checkbox"/> Fire pumps <input type="checkbox"/> Fixed extinguishing systems <input type="checkbox"/> Hood extinguishing systems(s) <input type="checkbox"/> Pre-action sprinkler systems <input type="checkbox"/> Standpipe systems <input type="checkbox"/> Wet sprinkler systems	<input type="checkbox"/> Yes	<input type="checkbox"/> No	<input type="checkbox"/> N/A
Fire/Smoke Dampers	<input type="checkbox"/> Yes	<input type="checkbox"/> No	<input type="checkbox"/> N/A
Fuel Gas Systems	<input type="checkbox"/> Yes	<input type="checkbox"/> No	<input type="checkbox"/> N/A
General <input type="checkbox"/> Wayfinding <input type="checkbox"/> Building identification <input type="checkbox"/> Labeled fire rated partitions/walls	<input type="checkbox"/> Yes	<input type="checkbox"/> No	<input type="checkbox"/> N/A
Knox Box <input type="checkbox"/> Fire Department <input type="checkbox"/> Bryan FD <input type="checkbox"/> College Station FD <input type="checkbox"/> University Police Department	<input type="checkbox"/> Yes	<input type="checkbox"/> No	<input type="checkbox"/> N/A
Smoke Management Systems	<input type="checkbox"/> Yes	<input type="checkbox"/> No	<input type="checkbox"/> N/A
Special Gas/Monitoring Equipment	<input type="checkbox"/> Yes	<input type="checkbox"/> No	<input type="checkbox"/> N/A
Stairwell Pressurization	<input type="checkbox"/> Yes	<input type="checkbox"/> No	<input type="checkbox"/> N/A
Other:	<input type="checkbox"/> Yes	<input type="checkbox"/> No	<input type="checkbox"/> N/A

Project Complete: Yes No

AHJ (or designee) Signature: _____

Comments:

Revision Log

Revision Date	Reviewers	Comments